

FUJIFILM

DIGITAL CAMERA

FinePix A700

OWNER'S MANUAL

This manual will show you how to use your FUJIFILM DIGITAL CAMERA FinePix A700 correctly. Please follow the instructions carefully.



digital
tools for the imagination.



xD
xD-Picture Card™

Exif Print

PictBridge

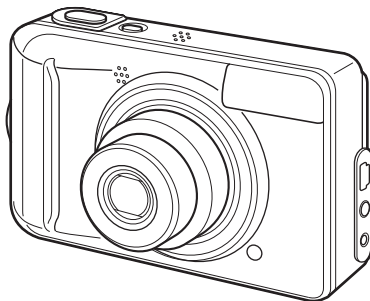

Getting Ready

Using the Camera

Advanced Features • Photography

• Playback

• Movie

Settings

Camera Connection

Software
Installation

Appendices

Troubleshooting

BL00570-200(1)



Warning

To prevent fire or shock hazard, do not expose the unit to rain or moisture.

For customers in the U.S.A.

*Tested To Comply
With FCC Standards
FOR HOME OR OFFICE USE*

FCC Statement

This device complies with part 15 of the FCC Rules.

Operation is subject to the following two conditions:

- (1) This device may not cause harmful interference, and
- (2) this device must accept any interference received, including interference that may cause undesired operation.

CAUTION

This equipment has been tested and found to comply with the limits for a Class B digital device, pursuant to Part 15 of the FCC Rules. These limits are designed to provide reasonable protection against harmful interference in a residential installation. This equipment generates, uses, and can radiate radio frequency energy and, if not installed and used in accordance with the instructions, may cause harmful interference to radio communications. However, there is no guarantee that interference will not occur in a particular installation. If this equipment does cause harmful interference to radio or television reception, which can be determined by turning the equipment off and on, the user is encouraged to try to correct the interference by one or more of the following measures:

- Reorient or relocate the receiving antenna.
- Increase the separation between the equipment and receiver.
- Connect the equipment into an outlet on a circuit different from that to which the receiver is connected.

— Consult the dealer or an experienced radio/TV technician for help.

You are cautioned that any changes or modifications not expressly approved in this manual could void the user's authority to operate the equipment.

Notes on the Grant:

To comply with Part 15 of the FCC rules, this product must be used with a Fujifilm-specified ferrite-core A/V cable, USB cable, and DC supply cord.

For customers in Canada

CAUTION

This Class B digital apparatus complies with Canadian ICES-003.

Please read the Safety Notes (→p.127) and make sure you understand them before using the camera.

NOTICE

BEFORE OPENING THE CD-ROM PROVIDED BY FUJIFILM CORPORATION, PLEASE READ THIS END USER LICENSE AGREEMENT CAREFULLY. ONLY IF YOU AGREE WITH THIS AGREEMENT, SHOULD YOU USE THE SOFTWARE RECORDED ON THE CD-ROM. BY OPENING THE PACKAGE, YOU ACCEPT AND AGREE TO BE BOUND BY THIS AGREEMENT.

End User License Agreement

This End User License Agreement ("Agreement") is an agreement between FUJIFILM Corporation ("FUJIFILM") and you, which sets forth the terms and conditions of the license granted for you to use the software provided by FUJIFILM.

The CD-ROM contains third party software. In case a separate agreement is provided by a third party supplier for its software, the provisions of such separate agreement shall apply to the use of such third party software, prevailing over those of this Agreement.

1. Definitions.

- (a) "Media" means the CD-ROM titled "Software for FinePix BZ" - which is provided to you together with this Agreement.
- (b) "Software" means the software which is recorded on Media.
- (c) "Documentation" means the operation manuals of Software and other related written materials which are provided to you together with Media.
- (d) "Product" means Media (including Software) and Documentation collectively.

2. Use of Software.

FUJIFILM grants to you a nontransferable, nonexclusive license:

- (a) to install one copy of Software onto one computer in binary machine executable form;
- (b) to use Software on the computer onto which Software is installed; and
- (c) to make one backup copy of Software.

3. Restrictions.

- 3.1 You shall not distribute, rent, lease or otherwise transfer all or any part of Software, Media or Documentation to any third party without FUJIFILM's prior written consent. You also shall not sublicense, assign or otherwise transfer all or any part of the rights granted to you by FUJIFILM under this Agreement without FUJIFILM's prior written consent.
- 3.2 Except as expressly granted by FUJIFILM hereunder, you shall not copy or reproduce all or any part of Software or Documentation.
- 3.3 You shall not modify, adapt or translate Software or Documentation. You also shall not alter or remove copyright and other proprietary notices that appear on or in Software or Documentation.
- 3.4 You shall not, or shall not have any third party, reverse-engineer, decompile, or disassemble Software.

4. Ownership.

All copyrights and other proprietary rights to Software and Documentation are owned and retained by FUJIFILM or the third party suppliers as indicated on or in Software or Documentation. Nothing contained herein shall be construed, expressly or implicitly, as transferring or granting any right, license, or title to you other than those explicitly granted under this Agreement.

5. Limited Warranty.

FUJIFILM warrants to you that Media is free from any defect in material and workmanship under normal use for ninety (90) days from the date of your receipt of Media. Should Media not meet the foregoing warranty, FUJIFILM shall replace such defective Media with other Media bearing no defect. FUJIFILM's entire liability and your sole and exclusive remedy with regard to any defect in Media shall be expressly limited to such FUJIFILM's replacement of Media as provided herein.

6. DISCLAIMER OF WARRANTY.

EXCEPT AS PROVIDED IN SECTION 5 HEREIN, FUJIFILM PROVIDES PRODUCT "AS IS" AND WITHOUT WARRANTIES OF ANY KIND, EXPRESS OR IMPLIED, FUJIFILM SHALL MAKE NO WARRANTY, EXPRESS, IMPLIED OR STATUTORY, AS TO ANY OTHER MATTERS, INCLUDING, BUT NOT LIMITED TO NON-INFRINGEMENT OF ANY COPYRIGHT, PATENT, TRADE SECRET, OR ANY OTHER PROPRIETARY RIGHTS OF ANY THIRD PARTY, MERCHANTABILITY, OR FITNESS FOR ANY PARTICULAR PURPOSE.

7. LIMITATION OF LIABILITY.

IN NO EVENT SHALL FUJIFILM HAVE ANY LIABILITY FOR ANY GENERAL, SPECIAL, DIRECT, INDIRECT, CONSEQUENTIAL, INCIDENTAL, OR OTHER DAMAGES (INCLUDING DAMAGES FOR LOSS OF PROFITS OR LOST SAVINGS) INCURRED FROM THE USE OF OR INABILITY TO USE PRODUCT EVEN IF FUJIFILM HAS BEEN ADVISED OF THE POSSIBILITY OF SUCH DAMAGES.

8. No export.

You acknowledge that neither Software nor any part thereof, will be transferred, or exported to any country or used in any manner in violation of any export control laws and regulations to which Software is subject.

9. Termination.

In case you breach any of the terms and conditions hereof, FUJIFILM may immediately terminate this Agreement without any notice.

10. Term.

This Agreement is effective until the date when you cease to use Software, unless earlier terminated in accordance with Section 9 hereof.

11. Obligation upon termination.

Upon termination or expiration of this Agreement, you shall, at your own responsibility and expense, delete or destroy immediately all Software (including its copies), Media and Documentation.

12. Governing Law.

This Agreement shall be governed by and construed in accordance with laws of Japan.

EC Declaration of Conformity

We

Name: Fuji Photo Film (Europe) GmbH
Address: Heesenstrasse 31
40549 Dusseldorf, Germany

declare that the product

Product Name: FUJIFILM DIGITAL CAMERA FinePix A700
Manufacturer's Name: FUJIFILM Corporation
Manufacturer's Address: 26-30, Nishiazabu 2-chome, Minato-ku,
Tokyo 106-8620, Japan

conforms to the following Standards:

Safety: EN60065
EMC: EN55022: 1998 Classe B
EN55024: 1998
EN61000-3-2: 1995 + A1: 1998 + A2: 1998

following the provision of the EMC Directive (89/336/EEC, 92/31/EEC and 93/68/EEC) and Low Voltage Directive (73/23/EEC).



Dusseldorf, Germany

September 1, 2006

Place

Date

Signature/Managing Director



This product comes with batteries. When these are empty, you shouldn't throw them away but deliver them as domestic chemical refuse.

Disposal of Electric and Electronic Equipment in Private Households

Disposal of used Electrical & Electronic Equipment (Applicable in the European Union and other European countries with separate collection systems)



This symbol on the product, or in the manual and in the warranty, and/or on its packaging indicates that this product shall not be treated as household waste.

Instead it should be taken to an applicable collection point for the recycling of electrical and electronic equipment.

By ensuring this product is disposed of correctly, you will help prevent potential negative consequences to the environment and human health, which could otherwise be caused by inappropriate waste handling of this product.

If your equipment contains easy removable batteries or accumulators please dispose these separately according to your local requirements.

The recycling of materials will help to conserve natural resources. For more detailed information about recycling of this product, please contact your local city office, your household waste disposal service or the shop where you have purchased the product.

In Countries outside the EU:

If you wish to discard this product, please contact your local authorities and ask for the correct way of disposal.

Contents

Warning.....	2
IMPORTANT	3
EC Declaration of Conformity.....	4
Disposal of Electric and Electronic Equipment in Private Households.....	5
Contents.....	6
Preface.....	8
About this Manual	10
Accessories Included	11
Camera Parts and Features.....	12
Example of LCD Monitor Text Display	13

Getting Ready

Loading the Batteries	14
Checking the battery charge	16
Loading the xD-Picture Card	17
Turning On and Off	19
Setting the Date and Time	20
Correcting the Date and Time.....	22
Selecting the Language	23

Using the Camera

Taking Pictures (QA AUTO Mode)	24
Taking pictures with the focus and exposure locked.....	28
Adjusting the shot composition	30
Viewing the Images.....	31
W Erasing the Images/Movies	34

Advanced Features — Photography



Using the Photography Functions — Procedure of Setting.....	36
--	----

Setting the Shooting Mode	38
M Macro (Close-up).....	40
L Setting the Flash.....	41
Photography Menu Operation	43
Setting the menus	43
Selecting quality setting (Q QUALITY).....	45
Taking pictures using self-timer (C SELF-TIMER)	46
Specifying sensitivity setting (ISO ISO).....	48
Adjusting exposure compensation (E EV).....	49
Adjusting color balance (WB WB).....	50

Advanced Features — Playback

Using Playback Menu.....	51
Setting the menus	51
DPOF set frame (D DPOF).....	51
Protecting the images (On PROTECT).....	54
Automatic Playback (PL PLAYBACK)	55
Copying the images (COPY COPY)	56
Recording voice memos (V VOICE MEMO).....	57
Playing back voice memo	59
Trimming (T TRIMMING)	61

Advanced Features — Movie

 Recording Movies	63
Changing movie size	65
 Playing Back Movies	66

Settings

Adjusting LCD Brightness or Playback Volume	67
 SET-UP	68
Using the SET-UP menu	68
SET-UP menu option	69

Camera Connection

Connecting to a TV	76
Connecting Camera Directly to Printer — PictBridge Function	77

Software Installation

Installation on a Windows PC	82
Pre-installation checklist	82
Installation on a Mac OS X	85
Pre-installation checklist	85
Connecting to a PC	88
Using FinePixViewer	92

Appendices

System Expansion Option	94
Accessories Guide	95
Using Your Camera Correctly	97
Power Supply and Batteries	98
Discharging rechargeable batteries	100
Notes on the xD-Picture Card™ and the Internal Memory	102
Warning Displays	104

Troubleshooting

Troubleshooting	108
-----------------------	-----

Specifications	114
Explanation of Terms	118
FUJIFILM Digital Camera Worldwide Network	120
Safety Notes	127

Preface

■ Test Shots Prior to Photography

For important photographs (such as weddings and overseas trips), always take a test shot and view the image to make sure that the camera is working normally.

- FUJIFILM Corporation cannot accept liability for any incidental losses (such as the costs of photography or the loss of income from photography) incurred as a result of faults with this product.

■ Notes on Copyright

Images recorded using your digital camera system cannot be used in ways that infringe copyright laws without the consent of the owner, unless intended only for personal use. Note that some restrictions apply to the photographing of stage performances, entertainments and exhibits, even when intended purely for personal use. Users are also asked to note that the transfer of **xD-Picture Card** containing images or data protected under copyright laws is only permissible within the restrictions imposed by those copyright laws.

■ Handling Your Digital Camera

This camera contains precision electronic components. To ensure that images are recorded correctly, do not subject the camera to impact or shock while an image is being recorded.

■ Liquid Crystal

If the LCD monitor is damaged, take particular care with the liquid crystal in the monitor. If any of the following situations arise, take the urgent action indicated.

- If liquid crystal comes in contact with your skin
Wipe the area with a cloth and then wash thoroughly with soap and running water.
- If liquid crystal gets into your eye
Flush the affected eye with clean water for at least 15 minutes and then seek medical assistance.
- If liquid crystal is swallowed
Flush your mouth thoroughly with water. Drink large quantities of water and induce vomiting. Then seek medical assistance.

■ Damaged by Water or Sand

FinePix A700 can be damaged on the inside and outside by water and sand. When you are at the beach or close to water, make sure that the camera is not damaged by water or sand. Take care not to place the camera on a wet surface.

■ Damaged by Condensation

If the camera is carried from a cold location into a warm place, water droplets (condensation) may form on the inside of the camera or on the lens. When this occurs, turn the camera off and wait an hour before using the camera. Condensation may also form on the **xD-Picture Card**. In this event, remove the **xD-Picture Card** and wait a short time.

■ Trademark Information

-  and **xD-Picture Card™** are trademarks of FUJIFILM Corporation.
- IBM PC/AT is a registered trademark of International Business Machines Corp. of the U.S.A.
- Macintosh, Power Macintosh, iMac, PowerBook, iBook and Mac OS are trademarks of Apple Computer, Inc., registered in the U.S. and other countries.
- Microsoft, Windows, and the Windows logo are trademarks, or registered trademarks of Microsoft Corporation in the United States and/or other countries. Windows is an abbreviated term referring to the Microsoft® Windows® Operating System.
- * The "Designed for Microsoft® Windows® XP" logo refers to the camera and the driver only.
- Other company or product names are trademarks or registered trademarks of the respective companies.

■ Notes on Electrical Interference

If the camera is to be used in hospitals or aircrafts, please note that this camera may cause interference to other equipment in the hospital or aircraft. For details, please check with the applicable regulations.

■ Explanation of Color Television System

- NTSC: National Television System Committee, color television telecasting specifications adopted mainly in the U.S.A., Canada and Japan.
- PAL: Phase Alternation by Line, a color television system adopted mainly by European countries and China.

■ Exif Print (Exif ver. 2.2)

Exif Print Format is a newly revised digital camera file format that contains a variety of shooting information for optimal printing.

- * See "Using Your Camera Correctly" (→p.97) for more information.

About this Manual

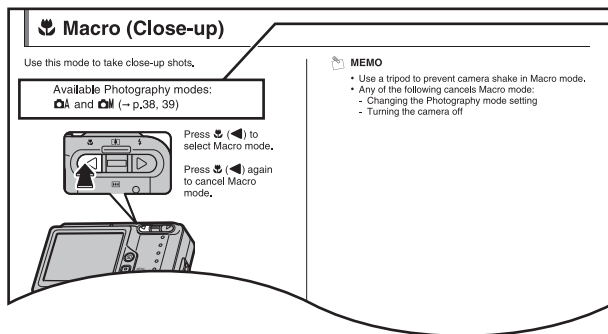

Icons indicate the modes that are available.

⚠ CAUTION

This mark denotes issues that may affect the camera's operation.

📌 CHECK

This mark denotes points to notice in the camera's operation.

📄 MEMO

This mark denotes additional topics that complement the basic operating procedures.

■ 4-direction (▲▼◀▶) button

Up, down, left, and right are indicated by black triangles in the Owner's Manual. Up or down is shown as ▲ or ▼, and left or right is shown as ◀ or ▶.

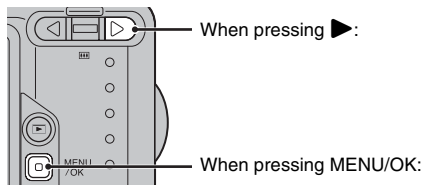

Accessories Included

- AA-size Alkaline Batteries (LR6) (2)

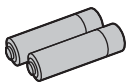

- Strap (1)

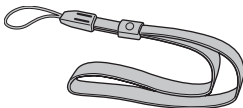

- A/V cable (1)
Including plug to pin-plug x2

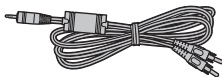

- USB cable (mini-B) (1)

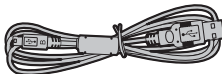

- CD-ROM (1)
Software for FinePix BZ



- Owner's Manual (this manual) (1)

Attaching the strap

Attach the strap as shown in 1 and 2.

When attaching the strap, move the fastener to adjust the length and slightly away from the end of the strap, as shown in figure 1.

1

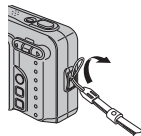

2



Camera Parts and Features

• Refer to the pages in parentheses for information on using the camera parts or features.

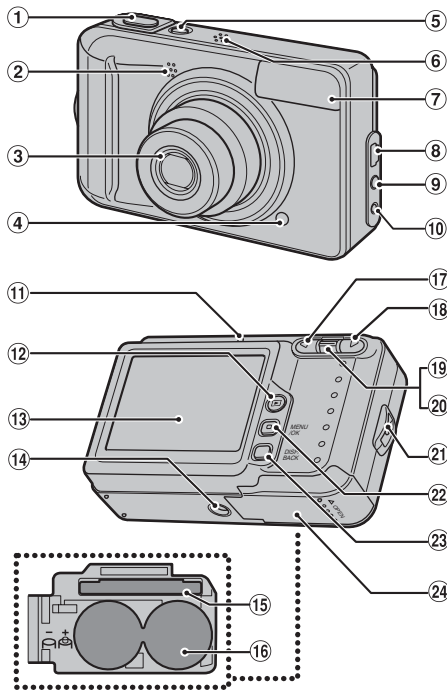

- ① Shutter button
- ② Microphone
- ③ Lens (lens cover)
- ④ Self-timer lamp (p.47)
- ⑤ POWER button
- ⑥ Speaker
- ⑦ Flash (p.41)
- ⑧ USB socket (mini-B)
- ⑨ A/V OUT (audio/visual output) socket (p.76)
- ⑩ DC IN 3V (power input) socket (p.76)
- ⑪ Indicator lamp (p.27)
- ⑫ Playback button
- ⑬ LCD monitor
- ⑭ Tripod mount
- ⑮ xD-Picture Card slot (p.17)
- ⑯ Battery compartment (p.15)
- ⑰ / Macro button (p.40)
- ⑱ / Flash button (p.41)
- ⑲ / Tele zoom switch (p.25, 32)
- ⑳ / Wide zoom switch (p.25, 32)
- ㉑ Strap mount
- ㉒ MENU/OK button
- ㉓ DISP (display) / BACK button (p.30, 31)
- ㉔ Battery cover (p.14)

Example of LCD Monitor Text Display

Photography mode

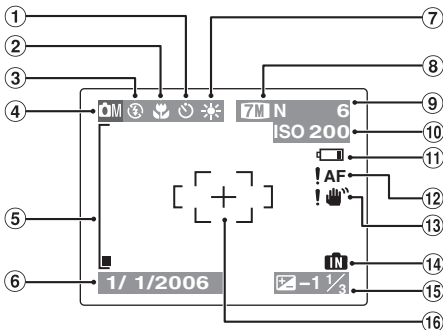

- ① Self-timer (p.46)
- ② Macro (close-up) (p.40)
- ③ Flash (p.41)
- ④ Photography mode (p.38)
- ⑤ Zoom bar (p.25)
- ⑥ Date (p.20)
- ⑦ White balance (p.50)
- ⑧ 7 N Quality mode (p.45)
- ⑨ Number of available frames (p.117)
- ⑩ ISO 200 Sensitivity (p.48)
- ⑪ Battery level warning (p.16)
- ⑫ AF warning (p.25)
- ⑬ Camera shake warning (p.26)
- ⑭ Internal memory (p.18)
- ⑮ Exposure compensation (p.49)
- ⑯ AF frame (p.25)

Playback mode

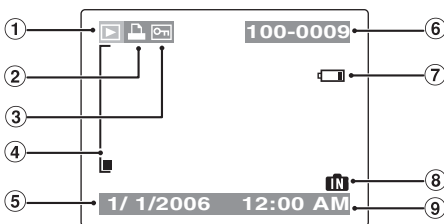

- ① Playback mode (p.31)
- ② DPOF (p.51)
- ③ Protection (p.54)
- ④ Zoom bar (p.32)
- ⑤ Date (p.20)
- ⑥ Frame number (p.71)
- ⑦ Battery level warning (p.16)
- ⑧ Internal memory (p.18)
- ⑨ Time (p.20)

FinePix A700 has internal memory that can store images without **xD-Picture Card**. **IN** appears on the LCD monitor when the internal memory is active.

Loading the Batteries

Batteries are required to operate the digital camera. At first, load the batteries in the camera.

Compatible batteries

AA-size alkaline batteries (2) or AA-size Ni-MH rechargeable batteries (2) (sold separately)

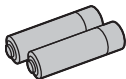

CAUTION

- Never use the following types of batteries, as they could cause serious problems such as battery fluid leakage or overheating:
 1. Batteries with split or peeling outer casings
 2. Combinations of different types of batteries or new and used batteries together
- Do not use manganese or Ni-Cd batteries.
- Use the same brand and grade AA-size alkaline batteries as those supplied with the camera.

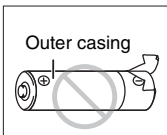

1 Open the battery cover.

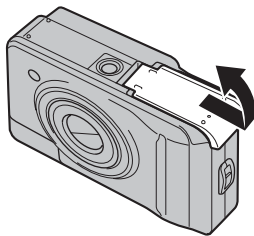

CHECK

Check that the camera is turned off before opening the battery cover.

CAUTION

- Do not open the battery cover while the camera is on. This could damage the **xD-Picture Card** or ruin the image files on the **xD-Picture Card**.
- Do not apply force to the battery cover.

- 2** Load the batteries correctly as indicated by the polarity icons.

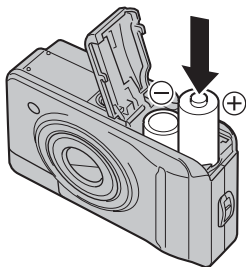

! **CAUTION**

Match the polarity icons (+ and -) of the batteries to those on the inside of the battery cover.

- 3** Close the battery cover.

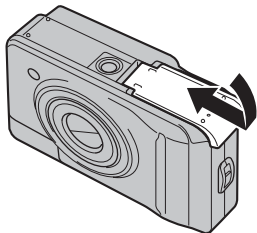

Checking the battery charge

Turn the camera on and check the battery charge.

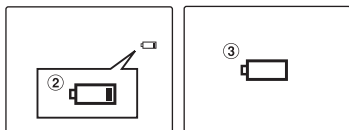

- ① There is ample battery charge. (Not displayed)
- ② There is insufficient charge left in the batteries. The batteries will soon run out. Have a new set of batteries ready. (Lit red)
- ③ The batteries are depleted. The display will shortly go blank and the camera will stop working. Replace or recharge the batteries. (Blinking red)

! CAUTION

- Soil, such as fingerprints on the poles of the batteries, can shorten time for which the batteries can be used.
- The time for which AA-size alkaline batteries (referred to hereafter simply as alkaline batteries) can be used varies depending on the brand. Some brands of alkaline batteries may stop providing power more quickly than those supplied with the camera. Note also that due to their nature, the time for which alkaline batteries can be used decreases in cold conditions (0°C to +10°C/+32°F to +50°F). For this reason, it is better to use AA-size Ni-MH batteries.
- Due to the nature of the battery, the battery level warning (☐ or ☐) may appear early when the camera is used in cold locations. Try warming the batteries in your pocket or a similar location before use.
- Depending on the battery type and the level of charge in the batteries, the camera may run out of power

without first displaying a battery level warning. This is particularly likely to happen when batteries that have run out of charge once are re-used.

- Depending on the camera mode, the transition from ☐ to ☐ may occur more quickly.
- Use Fujifilm Battery charger (sold separately) to charge AA-size Ni-MH batteries.
- See p.98-99 for information on the batteries.
- When first purchased or if left unused for a long period, the amount of time which AA-size Ni-MH batteries can be used may be short. See p.99 for more information.
- Battery power consumption varies greatly depending on use. When you change to Playback mode from Photography mode, ☐ may not occur, however, ☐ may suddenly blink red and the camera may stop operation.

Loading the xD-Picture Card

Although you can store pictures in the camera's internal memory, you can store many more images on the **xD-Picture Card** (sold separately). There is a slot for the **xD-Picture Card** inside the battery compartment.

1 Open the battery cover.

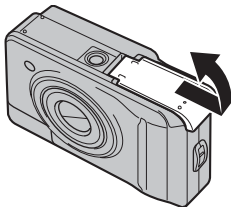

2 Insert an xD-Picture Card.

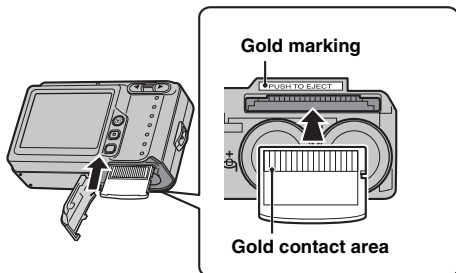

Align the gold marking with the gold contact area and insert it all the way into the slot.

3 Close the battery cover.

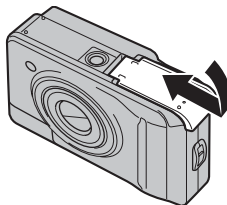

How to replace the xD-Picture Card

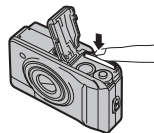

Push the **xD-Picture Card** into the slot and then slowly remove your finger. The lock is released and the **xD-Picture Card** is pushed out.

Continued ➔

! CAUTION

- When storing **xD-Picture Cards**, make sure that they are kept out of the reach of children. An **xD-Picture Card** could be swallowed and cause suffocation. If a child swallows an **xD-Picture Card**, seek medical attention or call emergency number right away.
- If the **xD-Picture Card** is oriented incorrectly, it will not go all the way into the slot. Do not apply force when inserting an **xD-Picture Card**.
- Note that the **xD-Picture Card** may spring out if you release your finger quickly from the card immediately after the lock is released.
- Operation of this camera is only guaranteed when it is used with FUJIFILM **xD-Picture Card**.
- See p.102 for information on the **xD-Picture Card**.

MEMO

- The size of an image file varies depending on the subject. For this reason, the number recorded may not represent the actual number of frames.
- See p.117 for information on standard number of available frames.

■ About internal memory

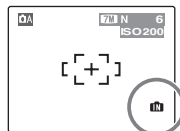

FinePix A700 has internal memory that can store images without **xD-Picture Card**.  appears on the LCD monitor when internal memory is active.

When an **xD-Picture Card** (sold separately) is inserted
[Record images]: Record images to an **xD-Picture Card**.

[Playback images]: Playback images in an **xD-Picture Card**.

When an **xD-Picture Card** (sold separately) is not inserted

[Record images]: Record images to internal memory.

[Playback images]: Playback images in internal memory.

■ About images in the internal memory

Images held in the camera's internal memory may be corrupted or erased due to problems such as camera faults. Save your important data to another media (i.e., DVD-R, CD-R, CD-RW, hard disk, etc.).

It is possible to transfer saved images on the internal memory to an **xD-Picture Card** (→p.56).

Turning On and Off

Turning the camera on in Photography mode

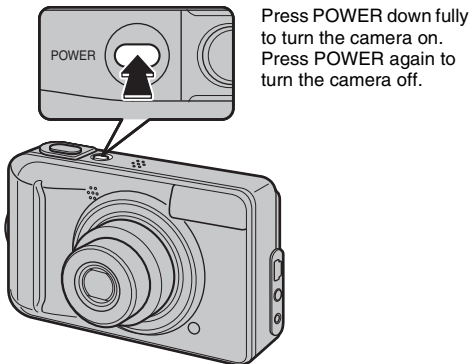

Press POWER down fully to turn the camera on. Press POWER again to turn the camera off.

Changes between Photography mode and Playback mode

Press  during shooting to change to Playback mode. Press the shutter button down halfway to return to Photography mode.

CAUTION

- The lens moves and the lens cover opens when turning the camera on in Photography mode. Take care not to obstruct the lens.
- Take care not to get fingerprints on the camera lens as this will result in impaired image quality in your shots.

Turning the camera on in Playback mode

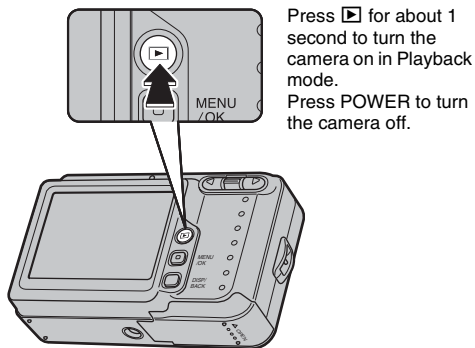

Press  for about 1 second to turn the camera on in Playback mode. Press POWER to turn the camera off.

MEMO

To change to Photography mode, press the shutter button down halfway.

Setting the Date and Time

When using the camera for the first time after purchasing, the date and time are cleared. Set the date and time.

1 “DATE/TIME NOT SET” message appears when turning the camera on.

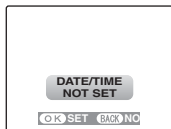

MENU
/OK

Press MENU/OK to set the date and time.

2 Set the date and time.

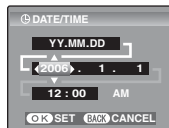

- ① Press ◀ or ▶ to select Year, Month, Day, Hour, or Minute.



- ② Press ▲ or ▼ to correct the setting.



MEMO

- Holding down ▲ or ▼ changes the numbers continuously.
- When the time displayed passes “12”, the AM/PM setting changes.

3 Change the date format.

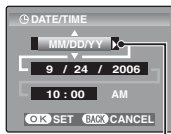

- ① Press ◀ or ▶ to select the date format.



- ② Press ▲ or ▼ to set the format.



MENU
/OK

- ③ Always press MENU/OK after the settings are completed.

Date format

YY.MM.DD: 2006.9.24

MM/DD/YY: 9/24/2006

DD.MM.YY: 24.9.2006



MEMO

“DATE/TIME NOT SET” message also appears when the batteries have been removed and the camera has been left for a long period.

Once the AC power adapter has been connected or the batteries have been installed for 30 minutes or more, the camera settings will be retained for roughly 2 hours even if both sources of power are removed.

Auto power off function

When the Auto power off function is active, if the camera is left unused for 2 or 5 minutes, this function turns the camera off (→p.73). To turn the camera back on, press POWER. To play back images, hold down ▶ for about 1 second.

Correcting the Date and Time

1 Open the SET-UP menu.

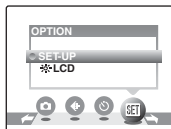

① Press MENU/OK to open the menu.



② Press ◀ or ▶ to select **SET** OPTION.



③ Press ▲ or ▼ to select SET-UP.



④ Press MENU/OK to open the SET-UP menu.

2 Display the DATE/TIME screen.

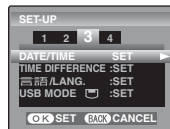

① Press ◀ or ▶ to select option 3.



② Press ▼ to select DATE/TIME.



③ Press ▶.
See “2 Set the date and time.”
(→p.20).

Selecting the Language

1 Open the SET-UP menu.

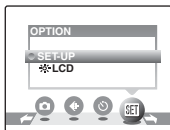

① Press MENU/OK to open the menu.



② Press ◀ or ▶ to select **SET** OPTION and then press ▲ or ▼ to select SET-UP.



③ Press MENU/OK to open the SET-UP menu.

2 Select the language.

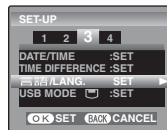

① Press ◀ or ▶ to move to option 3.



② Press ▲ or ▼ to select 言語/LANG..



③ Press ▶ to select ENGLISH, FRANCAIS, DEUTSCH, ESPAÑOL, ITALIANO, 中文簡, 繁體, 한글, РУССКИЙ, PORTUGUÊS, NEDERLANDS or TÜRKÇE. Press ▶ to cycle through the language settings.

Taking Pictures (📷 AUTO Mode)

This section describes the basic operations.

1 Turn the camera on.

Press POWER down fully to turn the camera on.

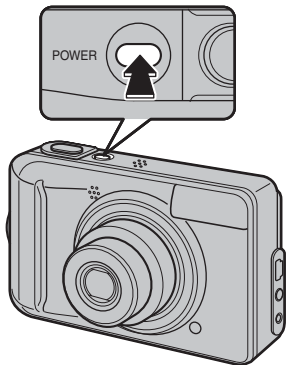

Holding the camera correctly

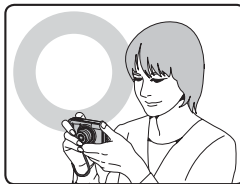

Brace your elbows against your sides and hold the camera with both hands.

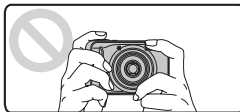

Do not cover the lens or flash with your fingers.

! CAUTION

- Moving the camera while shooting gives a blurred picture (camera shake). Hold the camera steadily with both hands.
- If the lens or flash is obscured by your fingers or the strap, subjects may be out of focus or the brightness (exposure) of your shot may be incorrect.

- 2** Check the composition on the LCD monitor.
To adjust zoom scale using the Zoom switch:

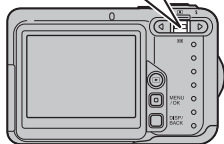
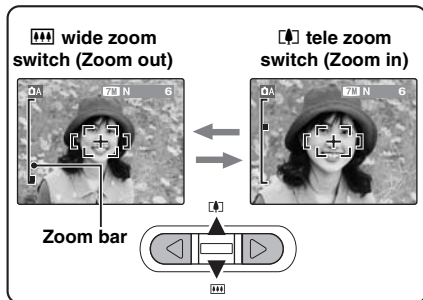

- **Focal range**
Approx. 50 cm (1.6 ft.)
to infinity
- **Optical zoom focal length (35 mm camera equivalent)**
Approx. 36 mm to
108 mm
- **Max. zoom scale**
3x

MEMO

- Select Macro mode to take close-up shots (→p.40).
- Use digital zoom when you want to shoot the subject closer (→p.72).

- 3** Focus on the main subject in the AF frame and press the shutter button down halfway.

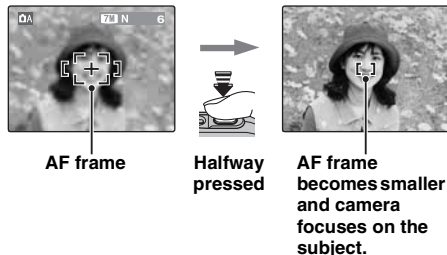

CHECK

- **Focus on the subject**
Double beep is heard
Indicator lamp lit green
- **Not focus on the subject**
No sound
!AF indicated
Indicator lamp blinking green

MEMO

- The shutter button has a halfway point at which focus and exposure are automatically optimized before taking the picture by pressing fully down.
- When pressing the shutter button halfway, a lens operation sound may be heard.

Continued ➔

4 Press the shutter button fully.

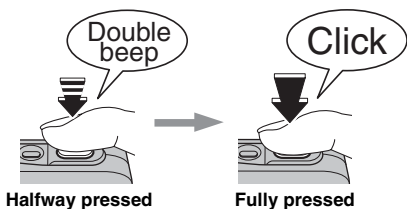

! CAUTION

When taking a picture using the flash, the image may disappear and go dark briefly due to flash charging. The Indicator lamp blinks orange during charging.

MEMO

- When the subject is not in the AF frame, use AF/AE lock to take the picture (→p.28).
- When pressing the shutter button down fully in one motion, the camera takes the picture without the AF frame changing.



Flash



When pressing the shutter button down halfway,  appears on the LCD monitor before the flash fires.

Change the flash mode when you want to take pictures without flash. See p.41 for information on flash.

! CAUTION

- If  F is selected for the quality setting, image recording time and time required between shots increases.
- The image shown on the LCD monitor before the picture is taken may differ in brightness, color, etc. from the image actually recorded. Play back the recorded image to check it (→p.31).
- When selecting a slow shutter speed that will cause camera shake,  appears on the LCD monitor. Use flash or a tripod.
- See p.104-107 for information on warning displays. See "Troubleshooting" (→p.108-113) for more information.

■ Indicator lamp display

The indicator lamp shows camera status lit or blinking when pressing the shutter button.

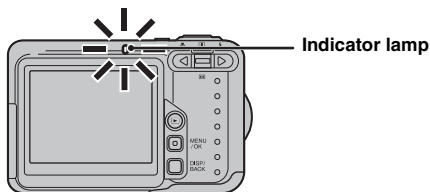

Display	Status
Lit green	Locking the focus
Blinking green	AF/AE in progress, camera shake warning, or AF warning (ready to shoot)
Blinking green and orange alternately	Recording to xD-Picture Card or internal memory (ready to shoot)
Lit orange	Recording to xD-Picture Card or internal memory (not ready)
Blinking orange	Charging flash (flash will not fire)
Blinking red	<ul style="list-style-type: none"> Warnings for xD-Picture Card and internal memory Card not formatted, incorrect format, memory full, xD-Picture Card or internal memory error Lens operation error

MEMO

Detailed warning messages appear on the LCD monitor (→p.104-107).

🔶 Taking pictures with the focus and exposure locked



In the above composition, the subjects (two people in this case) are not in the AF frame. Pressing the shutter button halfway at this point will result in the subjects being out of focus.

AF/AE lock is useful:

Use AF/AE lock to guarantee best result when shooting a subject that is not suited to autofocusing (→p.29).

Using AF/AE lock

- 1 Move the camera slightly so that one of the subjects is in the AF frame.

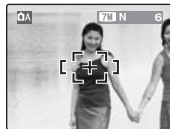

- 2 Press the shutter button down halfway to focus on the subject.

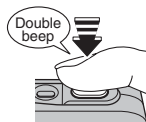

Halfway pressed



- 3** Continue to hold the shutter button down halfway. Move the camera back to the original image and press the shutter button fully.



 **MEMO**

- AF/AE lock can be applied repeatedly before the shutter is released.
- Use AF/AE lock in all Photography modes to guarantee excellent results.
- On FinePix A700, pressing the shutter button down halfway locks the focus and exposure settings (AF and AE lock).

Subjects not suitable for autofocus

FinePix A700 uses a high-precision autofocus mechanism. However, it may have difficulty focusing on the following:



Very shiny subjects such as a mirror or car body

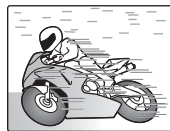

Fast moving subjects

- Subjects photographed through glass
- Subjects that do not reflect well, such as hair or fur
- Subjects with no substance, such as smoke or flames
- Dark subjects
- Subjects with little or no contrast between the subject and the background (such as subjects dressed in the same color as the background)
- Shots where another high-contrast object (not the subject) is close to the AF frame and is either closer or further away than your subject (such as a shot of someone against a background with strongly contrasting elements)

For such subjects use AF/AE lock (→p.28).

Adjusting the shot composition

Select the LCD monitor display.

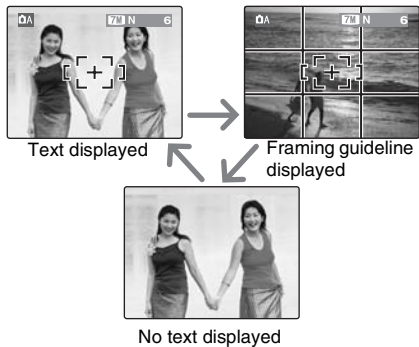
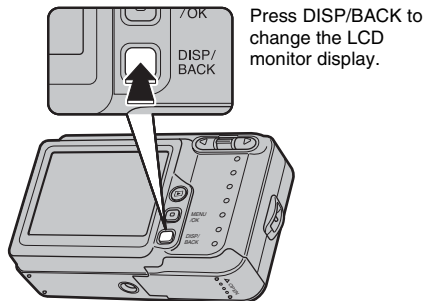

Best framing





Position the main subject at the intersection of two lines in this frame or align one of the horizontal lines with the horizon. Use this frame as a guide to the subject's size and the balance of the shot while composing a shot.

Viewing the Images

Playback your images to check them. For important photographs, always take a test shot and view the image to make sure that the camera is working normally.

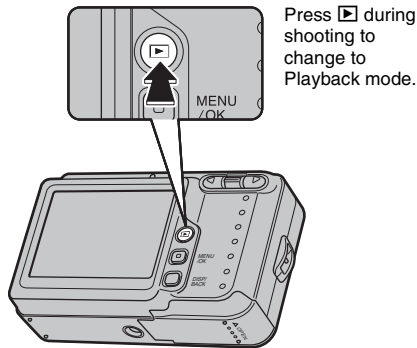
Setting the camera to Playback mode



When the camera is off, press  for about 1 second to turn the camera on in Playback mode.

MEMO

When pressing , the last image shot appears on the LCD monitor.

Select the LCD monitor display.

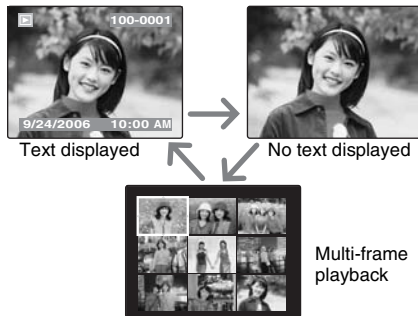
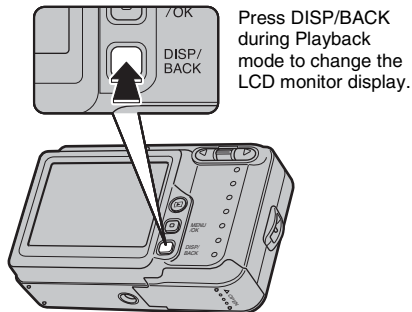

Single-frame playback



To select the required image:

Press ◀: last image

Press ▶: next image

Selecting images



To select images on the thumbnail lists screen, hold down ◀ or ▶ for 1 second during playback.

When releasing ◀ or ▶, camera returns to single-frame playback.

Playback zoom

1 Zoom in / Zoom out.

To zoom in an image during single-frame playback:

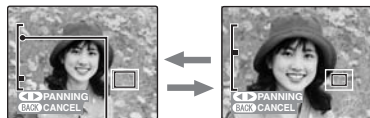

 switch
(Zoom out)

 switch
(Zoom in)

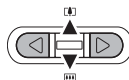

Zoom bar



Press  (▲) or  (▼) to zoom in or out on an image.

MEMO

Press DISP/BACK to cancel playback zoom.

2 Display another part of the image.

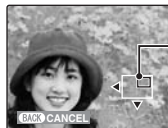

Navigation screen
(Current displayed image)



- ① Press ◀ or ▶ to move to another part of the image.



- ② Press ▲, ▼, ◀, or ▶ to display another part of the image.



MEMO

Press DISP/BACK to return to the zoom setting.

Zoom scales

Quality mode	Max. zoom scale
7M (3072 × 2304 pixels)	Approx. 4.8×
3:2 (3264 × 2176 pixels)	Approx. 4.5×
4M (2304 × 1728 pixels)	Approx. 3.6×
2M (1600 × 1200 pixels)	Approx. 2.5×



Multi-frame playback

Multi-frame playback screen (9 frames) appears on the LCD monitor. Select required frame from the 9 frames.



- ① Press ▲, ▼, ◀, or ▶ to move the cursor (colored frame) to the selecting frame.
Press ▲ or ▼ repeatedly to jump to the next page.



- ② Press MENU/OK to enlarge the image.



Still images viewable on FinePix A700

This camera will display still images recorded on FinePix A700 or still images (excluding some uncompressed images) recorded on any FUJIFILM digital camera that supports **xD-Picture Cards**. Clear playback or playback zooming may not be possible for still images shot on cameras other than FinePix A700.

Use this mode to erase unnecessary images or movies to have ample free space on the xD-Picture Card or internal memory.

Selecting FRAME or ALL FRAMES

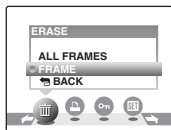

① Press MENU/OK to open the Playback menu.



② Press ◀ or ▶ to select  ERASE.



③ Press ▲ or ▼ to select FRAME or ALL FRAMES.



④ Press MENU/OK to confirm your selection.

Erasing one frame at a time (FRAME)

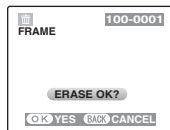

① Press ◀ or ▶ to select the erasing frame (file).



② Press MENU/OK to erase the currently displayed frame (file).

MEMO

To erase another frame (file), repeat above steps. When erasing frames (files) is completed, press DISP/BACK.

CAUTION

Pressing MENU/OK repeatedly erases consecutive frames (files). Take care not to erase a frame (file) by mistake.

Erasing all frames (ALL FRAMES)

MENU
/OK

Press MENU/OK to erase all the frames (files).



MEMO

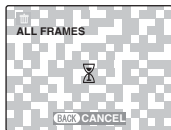

Press DISP/BACK to cancel erasing of all the frames (files). Some unprotected frames (files) will be left unerased.



MEMO

- When using an **xD-Picture Card**, the images in the **xD-Picture Card** are erased. When not using an **xD-Picture Card**, the images in the internal memory are erased.
- Selecting  BACK returns to single-frame playback without erasing any frames (files).
- Protected frames (files) cannot be erased. Unprotect the frames (files) before erasing them (→p.54).
- If "DPOF SPECIFIED. ERASE OK?" or "DPOF SPECIFIED. ERASE ALL OK?" appears, press MENU/OK again to erase the frames (files).



CAUTION

Erased frames (files) cannot be recovered. Back up important frames (files) onto your PC or another media.

Using the Photography Functions — Procedure of Setting

Specify the camera settings for taking pictures to get the best result. A general guide is given below.

1 Select the Photography mode.

Set the Photography mode from the menu.
The camera settings are tailored to the scene being shot.

AUTO	This is the easiest mode for taking pictures (→p.38).
PORTRAIT LANDSCAPE SPORT NIGHT	Select the best Shooting mode for the scene being shot (→p.38-39).
MANUAL	This mode provides detailed settings that are impossible to set in AUTO mode (→p.39).

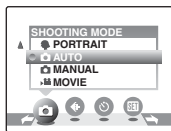

2 Specify the photography settings.





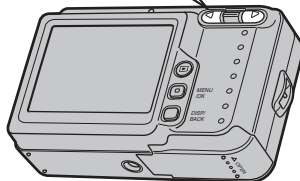
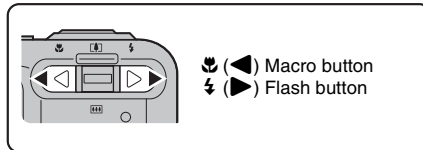

Pressing buttons or selecting menu allows you to specify photography functions. You can obtain the best result for shooting.

■ Specifying functions using buttons

Macro	Used for close-up shots (→p.40).
Flash	Used for shots in dark locations or for backlit subjects, etc. (→p.41).



■ Specifying functions using Photography menu (MENU/OK button)

 QUALITY	Use to specify required image size (→p.45).
 SELF-TIMER	Used in situations such as group shots where the photographer is included in the shot (→p.46).
 ISO	Use to specify required sensitivity setting (→p.48).
 EV	Use this setting to obtain the correct exposure (only ) (→p.49).
 WB	Use this setting to adjust the color balance to suit the color of the ambient light around the subject (only ) (→p.50).

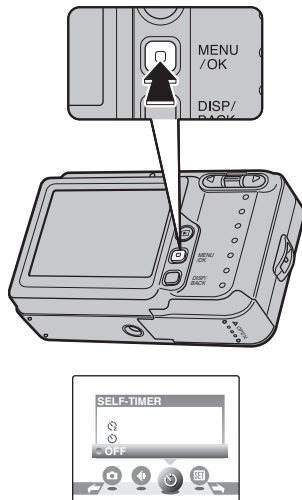

Setting the Shooting Mode

You can select the most suitable setting according to the subject by selecting one of the Shooting modes.

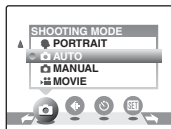

MENU
/OK

- 1 Press MENU/OK to open the menu.



- 2 Press ◀ or ▶ to select  SHOOTING MODE.



- 3 Press ▲ or ▼ to select Shooting mode.



MENU
/OK

- 4 Press MENU/OK to confirm the setting.

CHECK

See p.42 for information on available flash modes.

AUTO

This is the easiest mode for providing crisp and clear shots.

Use this mode for ordinary photography.

Camera specifies “EV” and “WB” settings automatically.

PORTRAIT

Use this mode for photography to get beautiful skin tones and soft overall tone.



LANDSCAPE

Use this mode for shooting scenery in daylight and provides crisp, clear shots of scenery such as buildings and mountains.



CHECK

Flash cannot be used in the Landscape mode.

SPORT

Use this mode to take pictures of a moving subject.

It gives priority to faster shutter speeds.



NIGHT

Use this mode for shooting evening and night scenes.



A picture is taken with a slow shutter of up to 2 seconds.



CHECK

Use a tripod to prevent camera shake, because a picture is taken with a slow shutter.

MANUAL

Set the  Exposure compensation (→p.49) and  White balance (→p.50) to manual to easily control yourself.

Macro (Close-up)

Use this mode to take close-up shots.

Available Photography modes:

 and  (→p.38, 39)



Press  (◀) to select Macro mode.

Press  (◀) again to cancel Macro mode.

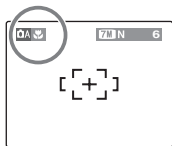
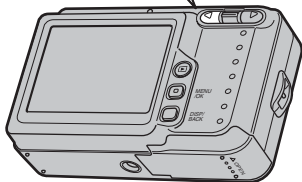

 appears on the LCD monitor indicating that you can take close-up shots.

CHECK

- Focal range
Wide-angle: approx. 10 cm to 80 cm (3.9 in. to 2.6 ft.)
Telephoto: approx. 35 cm to 80 cm (1.1 ft. to 2.6 ft.)
- Effective flash range
Approx. 30 cm to 80 cm (1.0 ft. to 2.6 ft.)

MEMO

- Use a tripod to prevent camera shake in Macro mode.
- Any of the following cancels Macro mode:
 - Changing the Photography mode setting
 - Turning the camera off

⚡ Setting the Flash

Flash photography is useful for taking pictures at night or indoor dark locations. Choose from 6 flash modes according to the type of shot.

Available Photography modes:

📷, 📷, 📷, 📷, 📷, 📷 (→p.38, 39)



The flash setting changes each time you press ⚡ (▶).

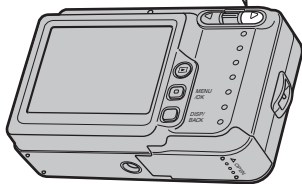
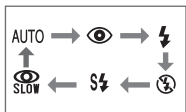

MEMO

When pressing the shutter button down halfway, **⚡** appears on the LCD monitor before the flash fires.

AUTO Auto flash (not displayed)

Use this mode for ordinary photography. The flash fires as required by the shooting conditions.

👁 Red-eye reduction

This mode is suitable for shooting portraits in low-light conditions.



Using this mode to minimize red-eye (eyes appear in red in the finished photo).

📄 Red-eye effect

When using the flash to take a picture of people in low-light conditions, their eyes sometimes appear red in the picture. This is caused by the light of the flash reflecting off the inside of the eye.

⚡ Forced flash

Use this mode in backlit scenes, or to get the correct colors when taking a picture under bright lighting. In this mode, the flash fires in bright as well as dark conditions.

Suppressed flash

This mode is suitable for situations where the flash cannot be used.

Use a tripod to prevent camera shake when shooting in Suppressed flash mode in the dark condition.
Any time, flash does not fire.

Slow synchro, Red-eye reduction + Slow synchro

This mode allows you to take pictures of people at night that clearly show both your subjects and the night time backdrop. To prevent camera shake, always use a tripod.

Using synchronizes Red-eye reduction mode.

Using selects slow shutter speeds of up to 2 seconds.

CAUTION

In bright scenes, overexposure may occur.

CHECK

• List of available flash modes in each Photography mode

The following table shows the flash modes available for each Photography mode.

	AUTO					
	✓	✓	✓	✓		
	✓	✓	✓	✓	✓	✓
				✓		
	✓		✓	✓		
				✓	✓	✓
	✓	✓	✓	✓	✓	✓

• Effective flash range (: AUTO)

Wide-angle: approx. 50 cm to 3.8 m (1.6 ft. to 12.5 ft.)

Telephoto: approx. 60 cm to 2 m (2.0 ft. to 6.6 ft.)

If you take pictures outside of the effective flash range, the image may appear dark even if the flash is used.

CAUTION

- If pressing the shutter button while the flash is charging (Indicator lamp blinking orange), the picture will be taken without the flash (when using AUTO or).
- The flash charging time may increase when the batteries are low on charge.
- When taking a picture using the flash, the image may disappear and go dark briefly due to flash charging. The Indicator lamp blinks orange during charging.
- The flash fires several times (pre-flashes and the main flash). Do not move the camera until the picture is taken.

Photography Menu Operation

Use the Photography menu to adjust image quality. You can take pictures in a wide range of conditions.

Setting the menus

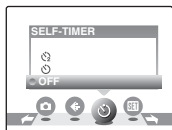

① Press MENU/OK to open the menu.



② Press ◀ or ▶ to select the menu.





































③ Press ▲ or ▼ to change the setting.



④ Press MENU/OK to confirm the setting.

■ List of photography menu options

Page	Menu	Functions	Settings	Factory default
1	 SHOOTING MODE (→p.38)	Use this setting to provide the best photography menu setting for the scene being shot.	 MOVIE /  MANUAL /  AUTO /  PORTRAIT /  LANDSCAPE /  SPORT /  NIGHT	 AUTO
	 QUALITY (→p.45)	This setting can be used with any of the modes. Specifies the image size. The larger image size, the better image quality is obtained. The smaller image size, the larger number of images are recorded.	 7M F /  7M N /  3:2 /  4M /  2M /  03M	 7M N
	 SELF-TIMER (→p.46)	This setting can be used with any of the modes. Used in situations such as group shots where the photographer is included in the shot.	OFF /  (10 seconds) /  (2 seconds)	OFF
	 OPTION (→p.68)	Use this setting to change the camera settings.	SET-UP /  LCD	—
2	 ISO (→p.48)	This setting can be used with any of the modes. Specifies required sensitivity setting of the ambient light around the subject. The larger value of the sensitivity, the higher sensitivity is obtained. The higher sensitivity settings will allow you to take pictures in darker locations.	AUTO / 100 / 200 / 400	AUTO
	 EV (→p.49)	This setting can be used when the Photography mode sets to  MANUAL ( M). Use this setting to obtain the correct exposure.	-2 EV to +2 EV (1/3 EV increments)	0
	 WB (→p.50)	This setting can be used when the Photography mode sets to  MANUAL ( M). Use this setting to adjust the color balance to suit the color of the ambient light around the subject.	AUTO /  * /  卷 /  荧 /  灯 /  日	AUTO

Selecting quality setting (QUALITY)

Available Photography modes:

(→p.38, 39)

Use this menu to specify the image size.
Select the quality setting for the scene being shot.

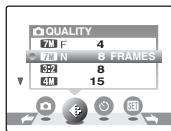

Quality settings in Photography mode

Quality mode	Sample uses
7M F (3072 × 2304)	Printing at up to 10R (25.4 × 30.5 cm / 10 × 12 in.) / A4 size For better quality, select 7M F
7M N (3072 × 2304)	
3:2 (3264 × 2176)	
4M (2304 × 1728)	Printing at up to 6R (15.2 × 20.3 cm / 6 × 8 in.) / A5 size
2M (1600 × 1200)	Printing at up to 4R (10.2 × 15.2 cm / 4 × 6 in.) / A6 size
09M (640 × 480)	To use for e-mail or web site

MEMO

- The bigger the number of recorded pixels, the better the image quality becomes. As the number of recorded pixels becomes smaller, you will be able to record more frames to an **xD-Picture Card**.
- The quality setting is retained even when the camera is turned off or the mode setting is changed.
- When changing the quality setting, the number of available frames also changes (→p.117). The numbers to the right of setting show the number of available frames.

CAUTION

If 7M F is selected for the quality setting, image recording time and time required between shots increases.

Area shot and quality setting

Area shot excluding 3:2



Area shot with 3:2



Normal shooting provides an aspect ratio of 4:3 and 3:2 shooting provides an aspect ratio of 3:2 (same aspect ratio as 35 mm film and post card).

⬡ Taking pictures using self-timer (⌚ SELF-TIMER)

Available Photography modes:

📷, 📷, 📷, 📷, 📷, 📷 (→p.38, 39)

Use this menu in situations where the photographer is included in the shot.

When selecting the self-timer setting, the self-timer icon appears on the LCD monitor.

⌚: The picture is taken after 10 seconds.

⌚: The picture is taken after 2 seconds.

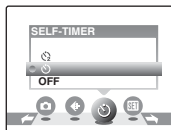

- 1 Press the shutter button down halfway to focus on the subject and press the shutter button fully.

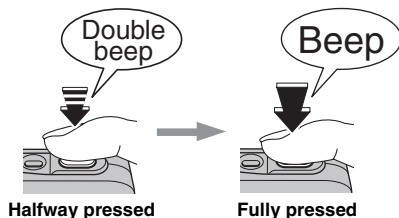

Pressing the shutter button down halfway that focuses on the subject.

Without releasing the shutter button, press the button all the way down (fully pressed) to start the self-timer.

2 Take pictures in selected time.

A picture is taken after the self-timer lamp changes from lit to blinking (only blinks with the 2-second self-timer).

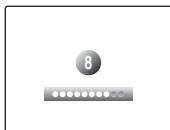
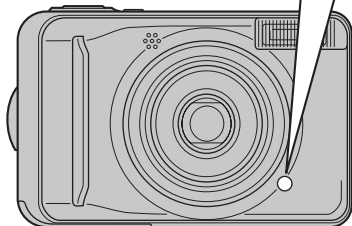
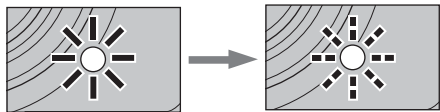

A countdown appears on the LCD monitor indicating the time remaining until the picture is taken.

Using the 2-second self-timer

This is useful when you worry about camera shake even if attaching the camera on a tripod.

MEMO

- To stop the self-timer, once it has started running, press DISP/BACK.
- Any of the following cancels the self-timer setting:
 - Completing the shooting
 - Changing the Photography mode setting
 - Setting the camera to Playback mode
 - Turning the camera off
- Take care not to stand in front of the lens when pressing the shutter button as this can prevent the correct focus or brightness (exposure) from being achieved.

Specifying sensitivity setting (ISO ISO)

Available Photography modes:



(→p.38, 39)

Use this menu to specify required sensitivity setting of the ambient light around the subject.

The larger value of the sensitivity, the higher sensitivity is obtained. The higher sensitivity settings will allow you to take pictures in darker locations.

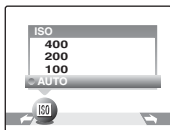

✓ CHECK

• Settings

AUTO/100/200/400

Selecting AUTO as the sensitivity setting, the camera selects the best sensitivity setting for the subject's brightness.

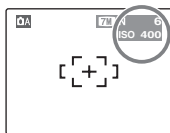

The selected sensitivity setting appears on the LCD monitor when the sensitivity setting is set to another setting excluding AUTO.

MEMO

Sensitivity is retained even when the camera is turned off or the mode setting is changed.

! CAUTION

Although higher sensitivity settings will allow you to take pictures in darker locations, they will also increase the amount of speckling in your images. Choose the sensitivity setting that best suits the conditions.

Adjusting exposure compensation (EV)

Available Photography mode:  (→p.38, 39)

Use this menu for shots to get the correct brightness (exposure), such as shots with extremely high contrast between the subject and the background.

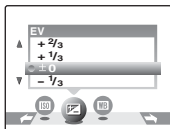

positive (+) compensation





negative (-) compensation



CHECK



- Compensation range: -2 EV to +2 EV (13 steps in 1/3 EV increments)
- Explanation of Terms "EV" (→p.118)

Guide to compensation

- Backlit portraits: +2/3 EV to +1 2/3 EV
 
- Very bright scenes (such as snowfields) and highly reflective subjects: +1 EV
 
- Shots made up predominantly of sky: +1 EV
- Spotlit subjects, particularly against dark backgrounds: -2/3 EV
- Scenes with low reflectivity, such as shots of pine trees or dark foliage: -2/3 EV

MEMO

Any of the following disables exposure compensation:

- Using the flash in AUTO or  mode
- Shooting dark scenes in  mode

Adjusting color balance (WB WB)

Available Photography mode:  (→p.38, 39)

Adjust the color balance based on white to suit the color of the ambient light around the subject.

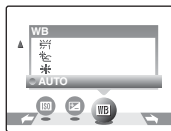

AUTO: Automatic adjustment

☀️: Shooting outdoors in good weather

☁️: Shooting in shade

💡: Shooting under Daylight fluorescent lamps

💡: Shooting under Warm White fluorescent lamps

💡: Shooting under Cool White fluorescent lamps

💡: Shooting in incandescent light

MEMO

- In AUTO mode, the correct white balance may not be achieved for subjects such as close-ups of people's faces and pictures taken under a special light source. Select the correct white balance for the light source.
- When the flash fires, the white balance setting for the flash is used. Consequently, to achieve a particular effect, the flash mode should be set to  Suppressed flash (→p.42).
- The color tones may vary depending on the shooting conditions (light source, etc.).

- After taking the picture, check the image color (white balance).
- Explanation of Terms "White Balance" (→p.119).

Using Playback Menu

Use this menu to playback photographed images.

Setting the menus



- 1 Set the camera to Playback mode (→p.31).

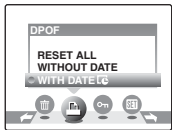

MENU
/OK

- 2 Press MENU/OK to open the menu.



- 3 Press ◀ or ▶ to select the menu.



- 4 Press ▲ or ▼ to change the setting.



MENU
/OK

- 5 Press MENU/OK to confirm the setting.

DPOF set frame (🖨️ DPOF)

You can specify the image, number of prints, with or without date of printing with a DPOF-compatible printer.

WITH DATE : The date will be imprinted on your prints.

WITHOUT DATE : The date will not be imprinted on your prints.

RESET ALL : All DPOF settings will be canceled.

WITH DATE / WITHOUT DATE

Selecting WITH DATE , appears on the LCD monitor and the date will be imprinted on your prints.

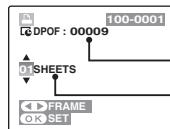

Total number of prints

Setting for that frame

Continued ➔

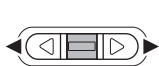

- ① Press ◀ or ▶ to display the frame (file) for specifying DPOF setting.



- ② Press ▲ or ▼ to set a value.
Up to 99 sheets are printed.
For frames (files) that you do not want printed, set the number of prints to 0 (zero).

To specify more DPOF settings, repeat steps ① and ②.



MENU
/OK

- ③ Always press MENU/OK after the settings are completed.
Pressing DISP/BACK cancels those settings.



MEMO Canceling DPOF setting

- ① Press MENU/OK to open the Playback menu.
- ② Press ◀ or ▶ to select DPOF.
- ③ Press ▲ or ▼ to select WITH DATE or WITHOUT DATE and press MENU/OK.
- ④ Press ◀ or ▶ to select the frame (file) with the DPOF setting you want to cancel.
- ⑤ Press ▼ to set the number of prints to 0 (zero).

To cancel the DPOF setting for another frame (file), repeat steps ④ and ⑤.

Always press MENU/OK to complete the settings.

- DPOF ALL RESET (→p.53)



MEMO

- When DPOF settings were specified on another camera.



When the data includes a frame (file) with DPOF settings that were specified on another camera, "RESET DPOF OK?" appears.

Pressing MENU/OK erases all of the DPOF settings already specified for each frame (file). Specify the DPOF setting for each frame (file) again.

- Prints of up to 999 frames (files) can be ordered on the same **xD-Picture Card**.
- DPOF settings cannot be specified for movies.

! CAUTION

- Pressing DISP/BACK while choosing settings will cancel all current settings. If there were previous DPOF settings, only the modifications are canceled.
- When selecting the WITH DATE setting, the date is imprinted on your shots using the Print Service or a DPOF-compatible printer (depending on the printer specifications, the date may not be printed in some cases).
- Images photographed with a camera other than FinePix A700 may not be specified DPOF settings.

RESET ALL

To cancel all DPOF settings:



Select RESET ALL in the Playback menu (→p.51).

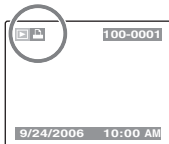

MENU /OK Press MENU/OK.

MEMO

 appears on the LCD monitor during playback when the image has specified DPOF settings.

How to specify print options (DPOF)

DPOF stands for Digital Print Order Format and refers to a format that is used for recording printing specifications for images shot using a digital camera on media such as an **xD-Picture Card**. The recorded specifications include information on which frames are to be printed.

This section gives a detailed description of how to order your prints with FinePix A700.

- * Some printers do not support date and time imprinting or specification of the number of prints.
- * The warnings shown below may appear while specifying the prints.

“DPOF SPECIFIED. ERASE OK ?”
 “DPOF SPECIFIED. ERASE ALL OK ?” (→p.35)
 When erasing the image, the DPOF setting for that image is deleted at the same time.

“RESET DPOF OK ?” (→p.52)
 When inserting an **xD-Picture Card** that contains images specified for printing by another camera, those print specifications are all reset and replaced by the new print specifications.

[DPOF FILE ERROR] (→p.106)
 Up to 999 images can be specified on the same **xD-Picture Card**.

Protecting the images (**ON** PROTECT)

Use this mode to prevent frames (files) from being accidentally erased. Your camera calls images "frames".

FRAME SET / RESET

To protect or unprotect only the selected frame (file):

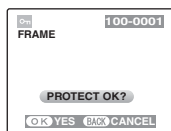

Unprotected

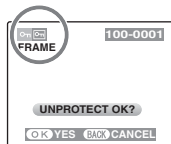

Protected (**ON** appears)



① Press ◀ or ▶ to select the protecting/unprotecting frame (file).



② Press MENU/OK to protect/unprotect the currently displayed frame (file).

Unprotected: protecting frame (file)

Protected: reset frame (file)

To protect another frame (file), repeat steps ① and ②.
When protecting frames (files) is completed, press DISP/
BACK.

SET ALL

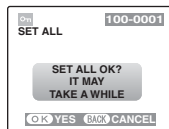

Press MENU/OK to protect all the frames (files).

RESET ALL

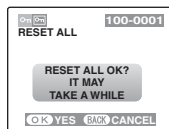

Press MENU/OK to unprotect all the frames (files).

To stop the procedure midway



If the images are very large, protecting or unprotecting all the frames (files) may take some time. If you want to take a picture or record a movie during the procedure, press DISP/BACK.

CAUTION

The Format function erases all the frames (files), including protected frames (files) (→p.73).

Automatic Playback (PLAYBACK)

Use this mode to play back photographed images continuously. You can select playback interval and type of image transition.

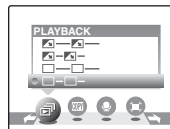

MEMO

- To interrupt  PLAYBACK, press ▲ or MENU/OK.
- Press ◀ or ▶ to advance or go back through the images.
- The Auto power off function (→p.73) does not operate during playback.
- Movie starts automatically. When the movie ends, the playback function moves it on.
- Press DISP/BACK once during playback to display the frame number and on-screen help.

Copying the images (COPY COPY)

It is possible to transfer saved images between the internal memory and an **xD-Picture Card**. Your camera calls images “frames”.

■ Selecting COPY

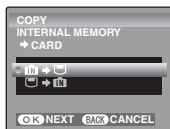

- 1 Press  or  to select  INTERNAL MEMORY → CARD or  →  INTERNAL MEMORY.



- 2 Press MENU/OK to confirm the setting.

Copying one frame at a time (FRAME)

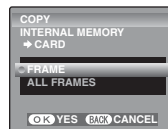



- 1 Press  or  to select FRAME.

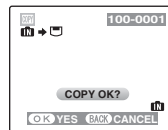

- 2 Press MENU/OK.



- 3 Press  or  to select the copying frame (file).



- 4 Press MENU/OK to copy the currently displayed frame (file).

MEMO

To copy another frame (file), repeat steps ③ and ④. When copying frames (files) is completed, press DISP/BACK.

Copying all frames (ALL FRAMES)

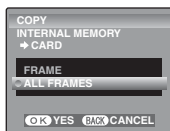

- ① Press ▲ or ▼ to select ALL FRAMES.



- ② Press MENU/OK.



- ③ Press MENU/OK to copy all the frames (files).

! CAUTION

- When [MEMORY FULL] or [MEMORY FULL] appears on the LCD monitor, exchanging the data stops on the way.
- When copying the image that has specified DPOF setting, the DPOF setting is not copied.

Recording voice memos (VOICE MEMO)

Voice memos of up to 30 seconds can be added to still images.

1 Set the menu.

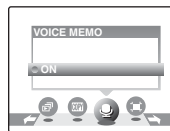

- ① Press ◀ or ▶ to select the image to add a voice memo.



- ② Press MENU/OK to open the Playback menu.



- ③ Press ◀ or ▶ to select VOICE MEMO.



- ④ Press MENU/OK.

Continued ➔

2 Start recording the voice memos.

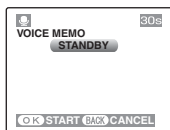
MENU
/OK

Press MENU/OK to start recording.

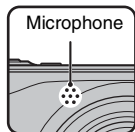

Face the microphone on the front of the camera to record your comment.

Hold the camera about 20 cm (7.9 in.) away for the best results.

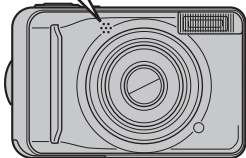

3 Camera operation while recording.

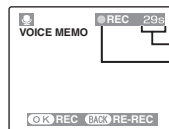

Remaining time
Blinking red

The remaining recording time appears during recording and the self-timer lamp blinks.

When the time remaining reaches 5 seconds, the self-timer lamp starts blinking quickly.

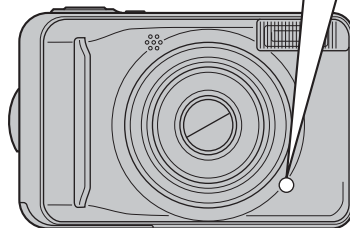
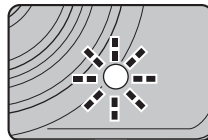

4 Ending voice memos.

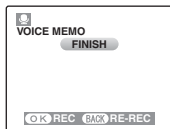

The voice memo ends when pressing MENU/OK midway or 30 seconds pass.

To record your comment: press MENU/OK.
To rerecord the comment: press DISP/BACK.

MEMO

- When the image already has a voice memo
If you select an image that already has a voice memo, a screen appears in which you can select whether to rerecord the memo.

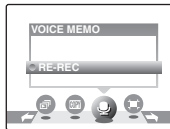

- When [PROTECTED FRAME] appears, unprotect the frame (→p.54).
- Voice memos cannot be added to movies.

Playing back voice memo



- Press ◀ or ▶ to select an image file with a voice memo.  appears on the LCD monitor.



- Press ▼ to start playing back voice memo.



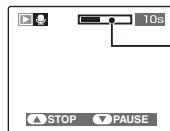

The playback time appears on the LCD monitor along with a progress bar.



Progress bar

Continued ➔

■ Playing back voice memos

	Control	Description
Playback		Playback begins. The voice memo stops when playback ends.
Pause / Resume		Pauses the voice memo during playback. Press ▼ again to resume playback.
Stop		Stops playback. Press ◀ or ▶ while voice memo playback is stopped to go back to the previous file or advance to the next file respectively.
Fast forward / Rewind		Press ◀ or ▶ during playback to skip forwards or backwards through the voice memo. These buttons do not function while playback is paused.

✓ CHECK

- Audio recording format:
WAVE (→p.118) PCM recording format
- Audio file size:
Approx. 480 KB (for a 30-second voice memo)

Playing voice memo files

You may not be able to play back some voice memo files recorded on other cameras.

! CAUTION

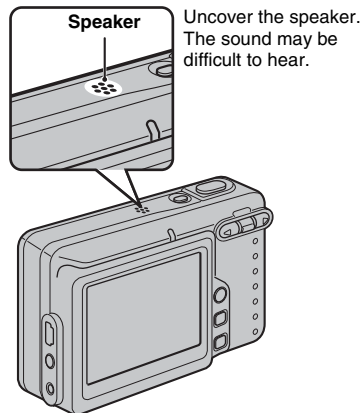

Trimming (TRIMMING)

Use this mode to trim the required part of the photographed image.

1 Select the menu.

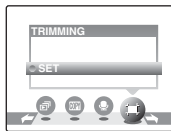

- ① Press ◀ or ▶ to select the trimming frame (file).



MENU
/OK

- ② Press MENU/OK to open the Playback menu.



- ③ Press ◀ or ▶ to select TRIMMING.



MENU
/OK

- ④ Press MENU/OK.

2 Specify trimming part of image.

switch



switch



Zoom bar

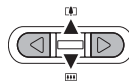

- ① Press ▲(▲) or ▼(▼) to zoom in or out on an image.



MEMO

Press DISP/BACK to return to single-frame playback.



Navigation screen
(Current displayed image)



- ② Press ◀ or ▶ to move to another part of the image.



- ③ Press ▲, ▼, ◀, or ▶ to display another part of the image.



MEMO

Press DISP/BACK to return to the zoom setting.



MENU
/OK

- ④ Press MENU/OK.

Continued ➔

3 Record the image.

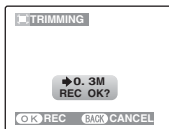

MENU
/OK

Check the saved image size and press MENU/OK.

The trimmed image is added as a separate file in the final frame.



MEMO

- A saved image size varies depending on the zoom scale of step 2. For 0.3 M, **OK** YES option appears in yellow.
- Image sizes

4M	Printing at up to 6R (15.2 × 20.3 cm/6 × 8 in.) / A5 size
2M	Printing at up to 4R (10.2 × 15.2 cm/4 × 6 in.) / A6 size
0.3M	To use for e-mail or web site

- When **3.2** quality setting is selected, the image is trimmed to normal size (4:3 aspect ratio).



CAUTION

You may not be able to trim images that were shot with a camera other than FinePix A700.

Recording Movies

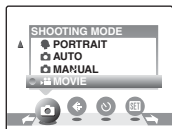

Use this mode to record movies with sound.

1 Set the camera to Movie mode.





1 Press MENU/OK to open the menu.



2 Press  or  to select  SHOOTING MODE.



3 Press  or  to select  MOVIE.



4 Press MENU/OK to confirm the setting.

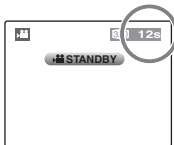

The available recording time appears on the LCD monitor.

Zooming the image

You must zoom beforehand as you cannot zoom during recording.

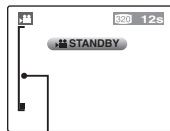

Zoom bar

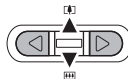

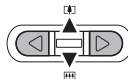
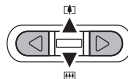
Press  (▲) or  (▼) to zoom in or out on an image.

CHECK

- Optical zoom focal length
Approx. 36 mm to 108 mm (35 mm camera equivalent)
Max. zoom scale: 3x
- Focal range
Approx. 50 cm (1.6 ft.) to infinity

Continued ➔

2 Record movies.



Fully pressed

Press the shutter button down fully to start recording. During recording, ●REC and a counter that shows the remaining time appear on the LCD monitor.

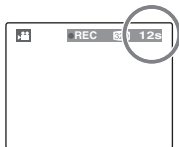

Halfway pressed

Recording ends when pressing the shutter button down halfway during recording or the remaining time runs out.

MEMO

There is no need to hold down the shutter button during recording.

Recording movies

- Specifications: Motion JPEG (→p.118) with monaural sound
- Quality selection method: **320** (320 × 240 pixels)
180 (160 × 120 pixels)
- Frame rate (→p.118): 10 frames per second (fixed)

MEMO

- The brightness and color of the LCD monitor shown during movie recording may differ from those shown before recording begins.
- Pressing the shutter button down fully fixes the focus, however the exposure and white balance are adjusted to the scene being shot.
- If recording is stopped immediately after it begins, 1 second of the movie is recorded onto the **xD-Picture Card** or internal memory.

CAUTION

- Because a movie is recorded onto the **xD-Picture Card** or internal memory as it is saved, it cannot be recorded correctly if the camera suddenly loses power (if the batteries run out or the AC power adapter is disconnected).
- A movie file taken by FinePix A700 may not be playable on other cameras.
- Because sound is recorded concurrently with the images, make sure that you do not cover the microphone with a finger, etc. (→p.12).
- Camera operation noises may be recorded during movie shooting.

Changing movie size

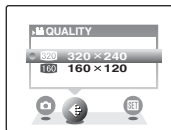
MENU
/OK

- 1 Press MENU/OK to open the menu.



- 2 Press ◀ or ▶ to select the ⏪ QUALITY setting.



- 3 Press ▲ or ▼ to change the setting.

MENU
/OK

- 4 Press MENU/OK to confirm the setting.

Quality settings in Movie mode

320 (320 × 240 pixels): For better quality

160 (160 × 120 pixels): To record longer movies



MEMO

- The quality setting is retained even when the camera is turned off or the mode setting is changed.
- The available recording time for a movie may decrease depending on the free space on the **xD-Picture Card**.
- See p.117 for information on standard number of available recording time.

! CAUTION

If you shoot using the **xD-Picture Cards** with model numbers containing “M” such as DPC-M2GB, movie recording time may be reduced if you repeatedly record and erase (frame erase) image files.

In such a case, erase all frames or format the **xD-Picture Card** before use. Back up important frames (files) onto your PC or another media.

▶ Playing Back Movies

Setting the camera
to **▶ Playback mode** (→p.31)

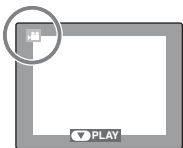

- ① Press ◀ or ▶ to select the movie file. appears on the LCD monitor.



- ② Press ▼ to begin playing back movie.

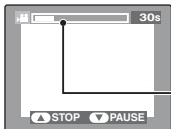

The playback time appears on the LCD monitor along with a progress bar.

Progress bar

■ Playing back movies

	Control	Description
Playback		Playback begins. Playback stops when the end of the movie is reached.
Pause / Resume		Pauses the movie during playback. Press ▼ again to resume playback.
Stop		Stops playback. Press ◀ or ▶ while playback is stopped to go back to the previous file or advance to the next file respectively.

	Control	Description
Fast forward / Rewind		Press ◀ or ▶ during playback to skip forwards or backwards through the movie.
Skip playback		Press ◀ or ▶ when the movie is paused, the movie advances or goes back one frame. Hold down ◀ or ▶ to move through the frames quickly.

MEMO

If the subject of the shot is very bright, white vertical streaks or black horizontal streaks may appear in the image during playback. This is normal.

CAUTION

- You may not be able to play back some movie files recorded on other cameras.
- To play back movie files on a PC, save the movie file on the **xD-Picture Card** or internal memory to the PC's hard disk and then play back the saved file.
- Uncover the speaker. The sound is difficult to hear.

Adjusting LCD Brightness or Playback Volume

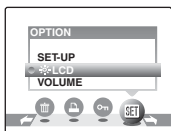

MENU
/OK

① Press MENU/OK to open the menu.



② Press ◀ or ▶ to select **SET** OPTION.



③ Press ▲ or ▼ to select ⚙ LCD or VOLUME.



MENU
/OK

④ Press MENU/OK to display the setting display.

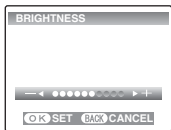

⑤ Press ◀ or ▶ to adjust the LCD monitor brightness or playback volume.



MENU
/OK

⑥ Press MENU/OK to confirm the setting.



MEMO

The options available in the **SET** menu vary depending on whether the mode is selected.

- Photography mode

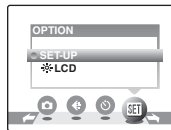

- Movie mode

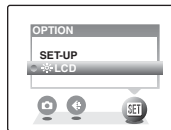

- Playback mode

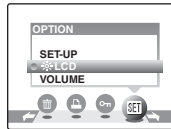

Using the SET-UP menu

1 Open the SET-UP menu.

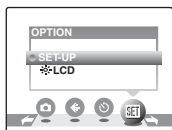

① Press MENU/OK to open the menu.



② Press ◀ or ▶ to select **SET** OPTION.



③ Press ▲ or ▼ to select SET-UP.



④ Press MENU/OK to display the SET-UP menu.

2 Change the setting.

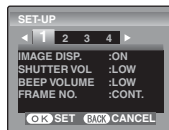

① Press ◀ or ▶ to move to options 1 to 4.



② Press ▲ or ▼ to select a menu option.



③ Press ◀ or ▶ to change the setting.
When selecting FORMAT, DATE/TIME, TIME DIFFERENCE, 言語/LANG., USB MODE, DISCHARGE, or RESET, press ▶ to specify each setting.





MENU/OK

④ Press MENU/OK to confirm the setting.

SET-UP menu option

	Setting	Display	Factory default	Explanation	Page
1	IMAGE DISP.	ON/OFF	ON	Specifies whether an image checking screen (photography result) appears after taking a picture. The image is displayed for a few moments and then recorded. The color tones in images recorded may differ from actual color. Play back the recorded images to check them.	–
	SHUTTER VOL	LOW/HIGH/OFF	LOW	Sets the volume of the sound emitted when the shutter operates.	–
	BEEP VOLUME	LOW/HIGH/OFF	LOW	Sets the volume of the tone emitted when the camera controls are used.	–
	FRAME NO.	CONT./RENEW	CONT.	Specifies whether frame numbers are assigned consecutively from previous numbers or begin again.	71
2	DIGITAL ZOOM	ON/OFF	OFF	Specifies whether digital zoom is used together.	72
	AUTO POWER OFF	2 MIN/5 MIN/OFF	2 MIN	Sets the time of turning camera off when camera is not used.	73
	LCD POWER SAVE	ON/OFF	ON	Darkens the LCD monitor when camera is not used.	73
	FORMAT	OK	–	Initializes an xD-Picture Card or internal memory. Select this menu to erase all the frames (files).	73

Continued ➔

	Setting	Display	Factory default	Explanation	Page
3	DATE/TIME	SET	–	Corrects the date or time.	22
	TIME DIFFERENCE	SET	–	Specifies the time difference settings.	74
	言語/LANG.	SET	–	Specifies the language used for LCD monitor display.	23
	USB MODE	SET	–	 DSC Provides a simple way to read images from an xD-Picture Card or internal memory and store images onto an xD-Picture Card .	88
 PICTBRIDGE When a printer that supports PictBridge is available, images can be printed by connecting the camera directly to the PictBridge-compatible printer without a PC.				77	
4	VIDEO SYSTEM	NTSC/PAL	–	Specifies whether video output is set to NTSC or PAL.	–
	DISCHARGE	OK	–	Discharges Ni-MH batteries.	100
	RESET	OK	–	Resets all the camera settings (other than the DATE/TIME, TIME DIFFERENCE, 言語/LANG., and VIDEO SYSTEM) to the factory default values set at shipment. A confirmation message appears when you press  . To reset the camera settings, press MENU/OK.	–

FRAME NO.

Use this function to specify whether frame numbers are assigned consecutively from previous numbers or begin again.

	< CONT. >	< RENEW >
A	0001 ⋮ 0005	0001 ⋮ 0005
↓		
B	0006 ⋮ 0010	0001 ⋮ 0005

* Formatted **xD-Picture Card** or internal memory used for both A and B.

CONT. : Pictures are stored beginning from the highest file number stored on the last **xD-Picture Card** or internal memory used.

RENEW: Pictures are stored on each **xD-Picture Card** beginning with a file number 0001.

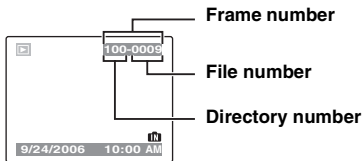
CHECK

The last 4 digits of the 7-digit number in the top right corner of the LCD monitor are the file numbers, while the first 3 digits show the directory number.

MEMO

- Setting this function to **CONT.** makes file management easier as it makes sure that file names are not duplicated when images are downloaded to a PC.
- When the camera settings are **RESET** (→p.70), the frame number setting (**CONT.** or **RENEW**) is changed to **CONT.** and the frame number itself does not return to 0001.
- In **CONT.** setting, images are stored beginning from the highest file number on the current **xD-Picture Card** when the **xD-Picture Card** already contains image files with file numbers higher than the highest file number on the last **xD-Picture Card**.
- File number runs from 0001 to 9999. Once 9999 is exceeded, the directory number changes from 100 to 101. The maximum number is 999-9999.
- The displayed frame number may differ for images photographed on other cameras.

DIGITAL ZOOM

Use this function to shoot enlarged images than maximum optical zoom scale.

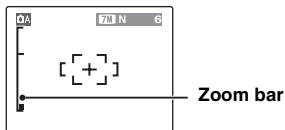

Zoom bar display

Digital zoom OFF



Optical zoom: 3x

Digital zoom ON



Digital zoom:
approx. 6.3x *

Optical zoom: 3x

* Approx. 5.4x (Digital zoom) when the QUALITY is set to .

CHECK

- Optical zoom focal length*
Approx. 36 mm to 108 mm
- Digital zoom focal length*
Approx. 108 mm to 680 mm,
max. zoom scale: approx. 6.3x
- Digital zoom focal length () *
Approx. 108 mm to 583 mm,
max. zoom scale: approx. 5.4x
* 35 mm camera equivalents

MEMO

When zooming changes between optical and digital, the position of the indicator stops. Press the same Zoom switch again to start the indicator moving again.

CAUTION

Using the digital zoom allows you to enlarge your subject and shoot it. However, it will lower your image quality. Set the digital zoom when requiring it.

AUTO POWER OFF

When this function is active and the camera remains unused for 2 or 5 minutes, it turns camera off. Use this function when you want to get the maximum possible running time from your batteries.

! CAUTION

The Auto power off function is disabled during automatic playback (→p.55), discharging rechargeable batteries (→p.100), and when a USB connection (→p.78, 88) is being used.

📄 To restore power to the camera

Refer to "Turning On and Off" (→p.19).

LCD POWER SAVE

The LCD monitor darkens when camera is not used for 10 seconds.

When this function is active, you can save power and get the maximum possible running time from your batteries.

📄 MEMO

Pressing any button wakes the camera up.

! CAUTION

The LCD power save function is disabled during Playback mode and Movie mode.

FORMAT

Initialize (format) the **xD-Picture Card** or internal memory for use with the camera.



Place of initialize

 **FORMAT:**
Internal memory

 **FORMAT:**
xD-Picture Card



① Press ◀ or ▶ to select OK.



② Pressing MENU/OK initializes the **xD-Picture Card** or internal memory.

✓ CHECK

Initializing internal memory takes about 15 seconds.

! CAUTION

- The Format function erases all the frames (files), including protected frames (files). Back up important frames (files) onto your PC or another media.
- Do not open the battery cover during formatting, as formatting will be interrupted.

TIME DIFFERENCE

Use this function when traveling to destinations in different time zones. This function sets a time difference relative to the date and time currently set. When this setting is enabled, the specified time difference is applied when pictures are taken.

1 Use Time difference function.

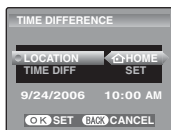

Press ◀ or ▶ to change between
 🏠 HOME and 📍 LOCAL.

To set the time difference, select
 📍 LOCAL.

🏠 HOME: Your home time zone
 📍 LOCAL: Your destination time
 zone



2 Select TIME DIFFERENCE.

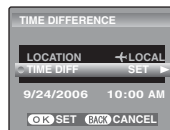

① Press ▲ or ▼ to select TIME
DIFF.



② Press ▶.

3 Set time difference.

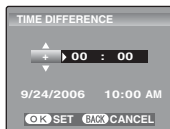

① Press ◀ or ▶ to select +/-, hour, and minute.



② Press ▲ or ▼ to change the setting.



MENU
/OK

③ Always press MENU/OK after the settings are completed.

✓ CHECK

Available time setting

-23:45 to +23:45 (in 15-minute increments)

📄 MEMO

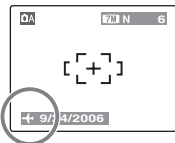

In the time difference setting, when you change to the Photography mode, + and the date is displayed for 3 seconds, the date display turns yellow.

✓ CHECK

Upon returning from a trip, always change the time difference setting back to HOME and then check the date and time again.

Connecting to a TV

When connecting to a TV, images can be displayed on wider screen. Using Automatic playback function (→p.55) together, you can have fun with folks.

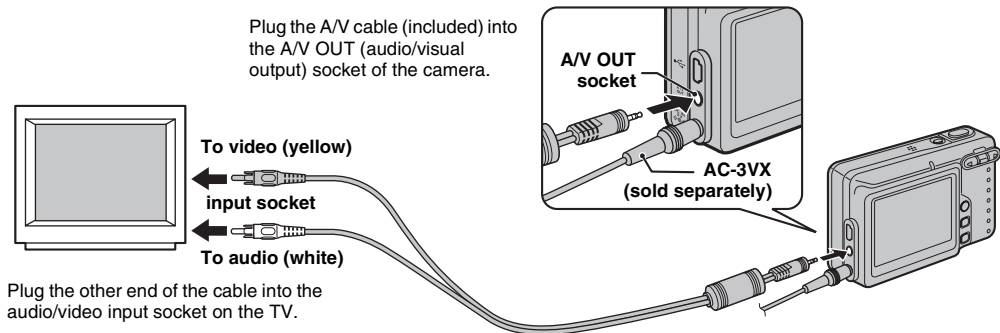

⚠ CAUTION

- Plug the A/V cable (included) and the AC power adapter correctly and push them in each terminal.
- See p.100 for the information of the AC power adapter.

📄 MEMO

- When connecting the A/V cable to TV, the LCD monitor is turned off.
- The image quality for movie playback is lower than for still images.
- Refer to the instructions provided with your TV for more information on audio/video input for your TV.
- Use the AC-3VX (sold separately) when FinePix A700 is connected to a TV for long periods.

Connecting Camera Directly to Printer — PictBridge Function



When a printer that supports PictBridge is available, images can be printed by connecting the camera directly to the PictBridge-compatible printer without a PC.

Before connecting to a printer

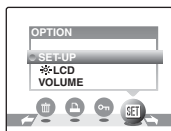



① Press  for about 1 second to turn the camera on in Playback mode.



② Press MENU/OK to open the menu.



③ Press  or  to select **SET** OPTION.





④ Press  or  to select SET-UP.





⑤ Press MENU/OK to open the SET-UP menu.



⑥ Press  or  to move to option 3.





⑦ Press  or  to select USB MODE.



⑧ Press .



⑨ Press  or  to select  PICTBRIDGE.



⑩ Press MENU/OK to confirm the setting.



⑪ Press POWER to turn the camera off.

Connecting to a printer

- 1 Connect the camera to your printer using the USB cable (mini-B).

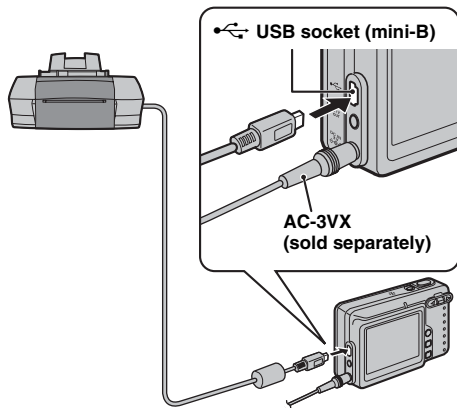

MEMO

Use the AC-3VX (sold separately) when FinePix A700 is connected to a printer for long periods.

- 2 Connect the camera to a printer before turning the printer on. Press for about 1 second to turn the camera on.



“CHECKING USB” appears on the LCD monitor.

- 3 The following screen appears on the LCD monitor after a moment.

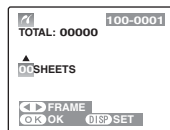

“Specifying images for printing” → p.79
 “Printing with DPOF setting” → p.80

MEMO

- If the screen of step 3 does not appear, check whether the USB MODE setting is PICTBRIDGE.
- Depending on the printer, some functions are disabled.

Specifying images for printing (PRINT WITH DATE / PRINT WITHOUT DATE)

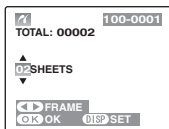

- 1 Press ◀ or ▶ to display the frame (file) for specifying PRINT setting.



- 2 Press ▲ or ▼ to set a value. Up to 99 sheets are printed.

To specify more PRINT settings, repeat steps ① and ②.



MENU
/OK

- 3 Press MENU/OK to display the confirm setting.

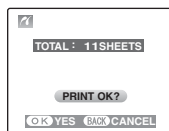

MENU
/OK

- 4 Press MENU/OK again to download the data to the printer and start printing the specified number of prints.



MEMO

Even if MENU/OK is pressed with total number of images set at 0 (zero), the image that is displayed is printed once.



Printing with date



- 1 Press DISP/BACK to display the setting display.
- 2 Press ▲ or ▼ to select PRINT WITH DATE LG.
- 3 Press MENU/OK.



CAUTION

PRINT WITH DATE LG is not available when the camera is connected to a printer that does not support date printing.

Printing with DPOF setting (PRINT DPOF)

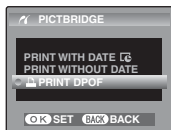

DISP/
BACK

① Press DISP/BACK to open the menu.



② Press ▲ or ▼ to select PRINT DPOF.



MENU
/OK

③ Press MENU/OK to display the confirm setting.



MENU
/OK

④ Press MENU/OK again to download the data to the printer and start printing the specified frames (files) continuously.

✓ CHECK

To select PRINT DPOF, the DPOF settings must be specified on FinePix A700 beforehand (→p.51).

! CAUTION

Even when WITH DATE is specified in the DPOF settings (→p.51), the date is not inserted on printers that do not support date printing.



MEMO



Press DISP/BACK to cancel the printing. Depending on the printer, the printing may not be canceled immediately or printing may stop midway through.

When printing stops midway, briefly turn the camera off and then on again.

Disconnecting the printer

- ① Check that "PRINTING" is not displayed on the camera's screen.
- ② Turn the camera off. Unplug the USB cable (mini-B).

MEMO

DPOF setting can be specified for images on internal memory.

CAUTION

- In PictBridge function, images photographed on other than a camera may not be printed.
- Do not connect to a PC when the USB MODE setting is set to  ⇌ PICTBRIDGE. See p.112 if you connect to a PC by mistake.
- The camera cannot be used to specify printer settings such as the paper size and print quality.
- Use internal memory or an **xD-Picture Card** that was formatted on FinePix A700.
- Movies cannot be printed.
- Images photographed with a camera other than FinePix A700 may not be printed.

Installation on a Windows PC

Pre-installation checklist

To run this software, you must have the hardware and software described below. Check your system before you begin the installation.

Operating System *1	Windows 98 (including the Second Edition) Windows Millennium Edition (Windows Me) Windows 2000 Professional*2 Windows XP Home Edition*2 Windows XP Professional*2
CPU	200 MHz Pentium minimum
RAM	64 MB minimum (128 MB minimum for Windows XP)
Hard disk space	Amount required for installation: 450 MB minimum Amount required for operation: 600 MB minimum
Display	800 × 600 pixels or better, 16-bit color or better
Internet connection *3	<ul style="list-style-type: none">• To use the FinePix Internet Service or mail attachment function: An Internet connection or e-mail transmission software is needed• Connection speed: 56 k bps or better recommended

*1 Models with one of the above operating systems pre-installed.

*2 When you install the software, login using a system administrator account (e.g. “Administrator”).

*3 Required to use the FinePix Internet Service. The software can still be installed even if you do not have an Internet connection.

■ Recommended system

Operating System	Windows XP
CPU	2 GHz Pentium 4 or better recommended
RAM	512 MB or better recommended
Hard disk space	2 GB or better
Display	1024 × 768 pixels or better, Highest (32 bit)
Internet connection	Broadband (ADSL, FTTH, CATV, etc.)

MEMO

- Connect the camera directly to the PC using the USB cable (mini-B). The software may not operate correctly when you use an extension cable or connect the camera via a USB hub.
- When your PC has more than one USB port, the camera can be connected to either port.
- Push the USB connector fully into the socket to ensure that it is securely connected. The software may not operate correctly if the connection is faulty.
- Additional USB interface board is not guaranteed.
- Windows 95 and Windows NT cannot be used.
- Operation is not guaranteed on home-built PCs or on PCs running updated operating system software.
- When you reinstall or remove FinePixViewer, the Internet menu and your user ID and password for the FinePix Internet Service are deleted from your PC. Click the [Register now] button, enter your registered user ID and password and download the menu again.

Do not connect the camera to your PC until the software installation is completed.

1 Install FinePixViewer as instructed in the Quick start guide.

Launching the installer manually

- ① Double-click the "My Computer" icon.
* Windows XP users should click "My Computer" in the "Start" menu.
- ② Right-click "FINEPIX" (CD-ROM drive) in the "My Computer" window and select "Open".
- ③ Double-click "SETUP" or "SETUP.exe" in the CD-ROM window.



- * The way file names are displayed differs as described below depending on your PC settings.
- File extensions (3-letter suffixes indicating the file type) may be shown or hidden. (e.g. Setup.exe or Setup)
 - Text may be shown normally or all in uppercase (e.g. Setup or SETUP).
-

2 Install DirectX as directed by the on-screen instructions and then restart your PC. If the latest version of DirectX is already installed on your PC, this installation is not performed.

! CAUTION

- If the latest version is already installed, this window does not appear.
- Do not remove the CD-ROM during this procedure.

3 After restarting the PC, a message appears stating "Installation of the FinePixViewer has been completed".

Installation on a Mac OS X

Pre-installation checklist

■ Hardware and software requirements

To run this software, you must have the hardware and software described below. Check your system before you begin the installation.

Compatible Mac *1	Power Macintosh G3*2, PowerBook G3*2, Power Macintosh G4, iMac, iBook, Power Macintosh G4 Cube, PowerBook G4, or Power Macintosh G5, MacBook, MacBook Pro, Mac mini
Operating System	Mac OS X (compatible with version 10.2.8 to 10.4.7)
RAM	192 MB minimum 256 MB or better recommended
Hard disk space	Amount required for installation: 200 MB minimum Amount required for operation: 400 MB minimum
Display	800 × 600 pixels or better, at least 32,000 colors
Internet connection *3	<ul style="list-style-type: none">• To use the FinePix Internet Service or mail attachment function: An Internet connection or e-mail transmission software is needed• Connection speed: 56 k bps or better recommended

*1 PowerPC, Intel processor loaded

*2 Models with a USB port as a standard feature

*3 Required to use the FinePix Internet Service. The software can still be installed even if you do not have an Internet connection.

MEMO

- Connect the camera directly to the Macintosh using the USB cable (mini-B). The software may not operate correctly if you use an extension cable or connect the camera via a USB hub.
- Push the USB connector fully into the socket to ensure that it is securely connected. The software may not operate correctly if the connection is faulty.
- Additional USB interface board is not guaranteed.

- 1 Turn your Macintosh on and start up Mac OS X. Do not launch any other applications.**
- 2 When the bundled CD-ROM is loaded into the CD-ROM drive, the “FinePix” icon appears. Double-click the “FinePix” icon to open the “FinePix” volume window.**

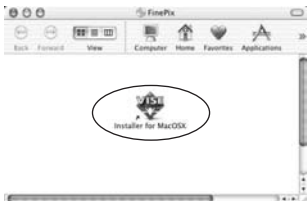

- 3 Double-click on “Installer for MacOSX”.**
- 4 The Installer setup dialog appears. Click the [Installing FinePixViewer] button.**



! CAUTION

For more information on what is installed, click the [Read Me First] button and [Using FinePixViewer] button.

- 5 The “Authenticate” dialog appears. Enter the name and password for the administrator account and then click the [OK] button.***
- * The administrator account is the user account used for Mac OS X installation and you can confirm the user account in the Accounts dialog in the System Preferences.
- 6 The “License” dialog appears. Read the agreement carefully and then, if you agree to the terms of the Agreement, click the [Accept] button.**
 - 7 The “Read me” dialog appears. Click the [Continue] button.**
 - 8 The “FinePixInstallIOSX” window appears. Click the [Install] button to install FinePixViewer.**



- 9** The “FinePixViewer installation completed” message dialog appears. Then click exit button and close it.

! CAUTION

When Safari is used as the Web browser, a message may be displayed and the CD-ROM may not be removed. If this happens, click the Safari icon in the Dock to make Safari the active application and then select “Quit Safari” in the “Safari” menu to shut down Safari.

- 10** Launch “Image Capture” from the “Applications” folder.

- 11** Change the Image Capture settings. Select “Preferences...” from the “Image Capture” menu.

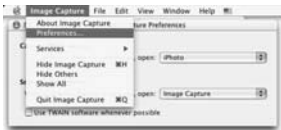

- 12** Select “Other...” from “When a camera is connected, open”.

- 13** Select “FPVBridge” from “FinePixViewer” folder in the “Applications” folder and click the [Open] button.



- 14** Select “Quit Image Capture” menu in the “Image Capture” menu.

Connecting to a PC

By connecting the camera to a PC, your system can be expanded to fill a wide range of uses. Using "FinePixViewer" performs images saving, browsing and file management etc.

MEMO

If the power cuts out during data transmission, the data will not be transmitted correctly. Always use the AC power adapter when connecting the camera to a PC.

Refer to Software Installation (→p.82, 85) the first time you connect the camera to your PC.

Install the software first. Do not connect the camera to the PC before installing all the software.

- 1 Insert the **xD-Picture Card** with images into the camera (→p.17).

CAUTION

- Do not format the **xD-Picture Card** in the camera on the PC.
- Use the **xD-Picture Card** with images taken by a FUJIFILM Digital camera.



- 2 Press for about 1 second to turn the camera on in Playback mode.



- 3 Press MENU/OK to open the SET-UP menu. Refer to "Using the SET-UP menu" (→p.68).



- 4 Select DSC in USB MODE in the SET-UP menu (→p.70).

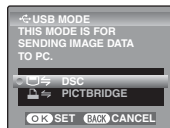

- 5 Press POWER to turn the camera off.

- 6 Turn your PC on.

- 7 Connect the camera to your PC using the USB cable (mini-B).

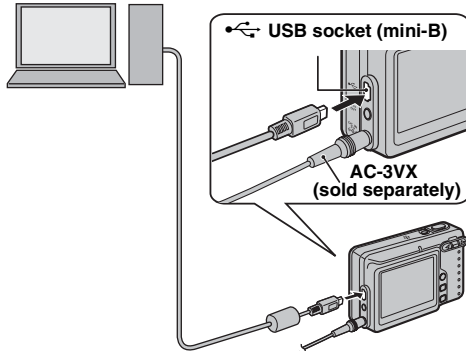



- ⑧ Press for about 1 second to turn the camera on in Playback mode.

! **When displaying “CHECKING USB”**

If “CHECKING USB” appears and then [COMMUNICATION ERROR] is displayed on the LCD monitor, DSC is not selected in USB MODE. Disconnect the USB cable (mini-B) to the camera and restart the procedure from step ③.

! **CAUTION**

- Always use the FUJIFILM AC Power Adapter AC-3VX (sold separately). If the camera suddenly loses power during data exchange, the **xD-Picture Card** or internal memory could be damaged.
- Do not disconnect the USB cable (mini-B) when the camera is communicating with a PC. If disconnecting the USB cable (mini-B) during communication, the files on the **xD-Picture Card** or internal memory may cause damage.
- In Mac OS X, you must set the automatic setup when the first time you connect the camera to your PC.
- Make sure that USB cable (mini-B) is connected correctly and pushed in.
- Perform pre-arranged steps to disconnect and turn off the camera (→p.91).
- When the camera and PC are exchanging data, the self-timer lamp blinks and the indicator lamp blinks orange.
- Auto power off is disabled during USB connection.
- Before replacing the **xD-Picture Card**, always disconnect the camera from the PC. See p.91 for information on the disconnection procedure.

- The camera and PC may be exchanging data even when “Copying” disappears on your PC screen. Before disconnecting the USB cable (mini-B), always check that the indicator lamp lights green.

- ⑨ Set a PC.

Windows 98 / 98 SE / Me / 2000 Professional / Macintosh

! **CAUTION**

The Windows CD-ROM may also be required during installation. In this event, change CD-ROMs as directed by the on-screen instructions.

- FinePixViewer automatically starts up and the Save Image Wizard window (Save Image dialog box) appears. Follow the instructions provided on screen to save the images. To proceed without saving the images, click the [Cancel] button.



* Screen for Windows 98 SE



MEMO

If you cancel saving by clicking the [Cancel] button, press **POWER** to turn off the camera and then disconnect it from the PC.

Continued ➔

- A removable disk icon appears and you can use your PC to transfer files to and from the camera.

Windows



Macintosh



If the above operations do not occur, you do not have the required software programs or drivers installed on your PC. Complete the required PC setup procedures. Then reconnect the camera to your PC.

Windows XP

- ① The “Found New Hardware” help message appears in the bottom-right corner of your screen. This message will close when the settings are completed. No action is required.

! CAUTION

This step is not required for subsequent connections.

- ② Specify the settings in the “AutoPlay” dialog box.

- **When FinePixViewer is included in the list of actions to perform**

Select “Viewing images using FinePixViewer” and then select the “Always do the selected action” checkbox. This checkbox may not be shown in some cases. Click the [OK] button to launch FinePixViewer.

- **When FinePixViewer is not included in the list of actions to perform**

Select “Take no action” and then select the “Always do the selected action” checkbox. This checkbox may not be shown in some cases.

Click the [OK] button and launch FinePixViewer manually.

- ③ A new removable disk icon appears in the “My Computer” window.

FinePixViewer automatically starts up and the Save Image Wizard window (Save Image dialog box) appears. Follow the instructions provided on screen to save the images. To proceed without saving the images, click the [Cancel] button.

📝 MEMO

If you cancel saving by clicking the [Cancel] button, press POWER to turn off the camera and then disconnect it from the PC.

Regarding the icons

The next time you connect the camera, the removable disk drive icon’s name changes to the “FinePix” icon and name.

Proceed to “Using FinePixViewer” (→p.92).

Disconnecting the camera

1 Windows

Once the image has been saved, the window below appears (Save Image Wizard Windows). To disconnect the camera, click the [Remove] button.



When the "It is now safe to disconnect the camera" message appears, click the [OK] button and disconnect the camera.

Macintosh

Once the image has been saved, the window below appears. To disconnect the camera, click the [OK] button.



2



① Press POWER to turn the camera off.

② Unplug the USB cable (mini-B) from the camera.

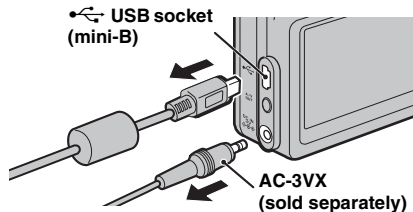

Using FinePixViewer

Mastering FinePixViewer

For all information on FinePixViewer functions, refer to “How to Use FinePixViewer” in the Help menu for details.

- **What is explained in “How to Use FinePixViewer”...** “How to Use FinePixViewer” covers a range of topics, including batch processing and ordering prints.

Example: Looking up slide shows

- ① Click “How to Use FinePixViewer” in the FinePixViewer Help menu.
- ② Click “Basic Operation” and then click “Slide Show” in the menu that appears.
- ③ The “Slide Show” information appears. Press the “<<<” key to view the previous page or the “>>>” key to view the next page.

Uninstalling the software

Only perform this operation when you no longer require the installed software or when the software was not installed correctly.

Windows

- ① Check that the camera is not connected to the PC.
- ② Quit all currently running applications.
- ③ Open the “My Computer” window. Then open the “Control Panel” and double-click on “Add/Remove Programs”.



- ④ The “Add/Remove Programs Properties” window appears. Select the software to be uninstalled (FinePixViewer or the driver) and then click the [Add/Remove] button.

To remove FinePixViewer

FinePixViewer Ver.4.3

To remove the driver software

FUJIFILM USB Driver



- ⑤ When the message appears, click the [OK] button. Check your selection carefully since the process cannot be canceled once you click the [OK] button.



- ⑥ Automatic uninstallation begins. When uninstallation ends, click the [OK] button.

Macintosh

Quit FinePixViewer. Then drag the installed FinePixViewer folder to the Trash and select “Empty Trash” in the “Finder” menu.

System Expansion Option

By using FinePix A700 together with other optional FUJIFILM products, your system can be expanded to fill a wide range of uses. Accessory availability may vary by country. Please check with your local Fujifilm representative to confirm product availability.

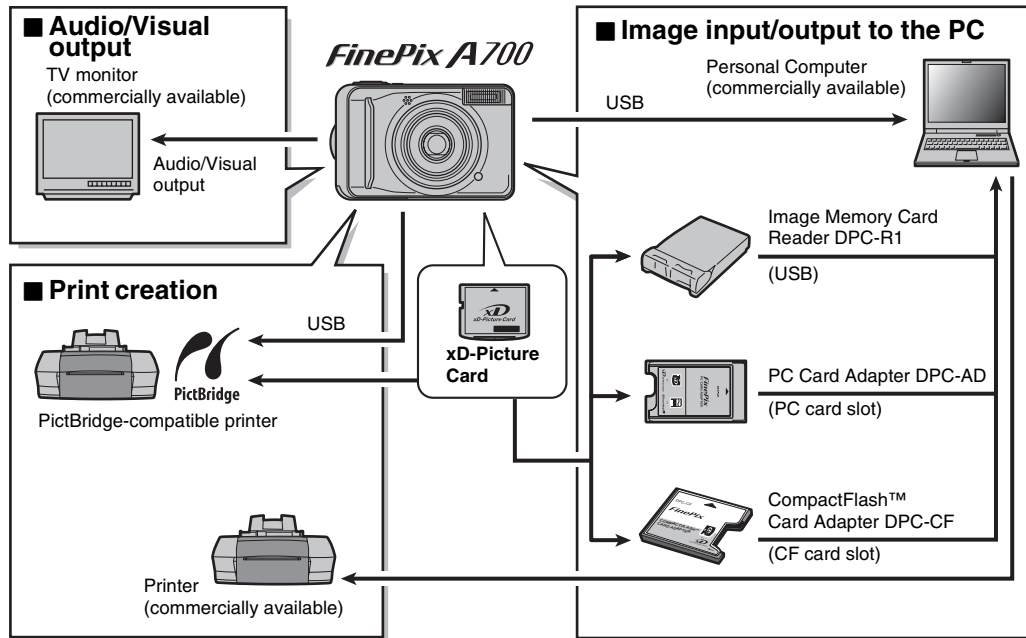

Accessories Guide

Visit the FUJIFILM web site for the latest information on camera accessories.

<http://www.fujifilm.com/products/digital/index.html>

Accessory availability may vary by country. Please check with your local Fujifilm representative to confirm product availability.

• **xD-Picture Card**

Use the following **xD-Picture Cards**:

16MB/32MB/64MB/128MB/256MB/512MB/1GB/2GB

There are two types of **xD-Picture Card**: standard type and Type M (containing "M" in the model number, such as DPC-M2GB).

FinePix A700 is compatible with Type M, however they may not be compatible depending on the device used (Image Memory Card Reader, etc.).



• **AC Power Adapter AC-3VX**

Use the AC-3VX when taking pictures or play back images for long periods or when FinePix A700 is connected to a PC.

* The shape of the AC power adapter, the plug, and socket outlet depend on the country.



• **Soft Case SC-FXA03**

This is a special case made of nylon that protects the camera against soil, dust, and minor impacts when it is being carried.

• **Soft Case SC-FXA04**

This is a special case made of polyurethane that protects the camera against soil, dust, and minor impacts when it is being carried.

Continued ➔

• **Image Memory Card Reader DPC-R1**

The DPC-R1 provides a quick and easy way to transfer images back and forth between your PC and an image memory card (**xD-Picture Card** and SmartMedia). The DPC-R1 uses the USB interface for high-speed file transfer.

-Compatible with **xD-Picture Card** of 16 MB to 512 MB, and SmartMedia of 3.3 V, 4 MB to 128 MB.

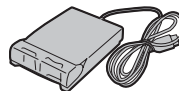

• **PC Card Adapter DPC-AD**

The PC Card Adapter allows the **xD-Picture Card** and SmartMedia to be used as a PC Card Standard ATA-compliant (PCMCIA 2.1) PC card (Type II).

-Compatible with **xD-Picture Card** of 16 MB to 512 MB, and SmartMedia of 3.3 V, 2 MB to 128 MB.



• **CompactFlash™ Card Adapter DPC-CF**

Loading an **xD-Picture Card** into this adapter allows you to use the card as a CompactFlash card (Type I).



Using Your Camera Correctly

Read this information and the “Safety Notes” (→p.127), to make sure you use your camera correctly.

■ Places to Avoid

Do not store or use the camera in the following types of locations:

- In the rain or in very humid, dirty, or dusty places
- In direct sunlight or in places subject to extreme temperature rises, such as in a closed car in summer
- Extremely cold places
- Places with strong vibration
- Places with smoke or steam
- Places subject to strong magnetic fields (such as near motors, transformers, or magnets)
- In contact with chemicals such as pesticides
- Next to rubber or vinyl products

■ Damaged by Water or Sand

FinePix A700 can be damaged on the inside and outside by water and sand. When you are at the beach or close to water, make sure that the camera is not damaged by water or sand. Take care not to place the camera on a wet surface.

■ Damaged by Condensation

If the camera is carried from a cold location into a warm place, water droplets (condensation) may form on the inside of the camera or on the lens. When this occurs, turn the camera off and wait an hour before using the camera. Condensation may also form on the **xD-Picture Card**. In this event, remove the **xD-Picture Card** and wait a short time.

■ When the Camera is Not Used or is stored Periods of Time

If you do not intend to use the camera for a long period of time, remove the batteries and the **xD-Picture Card**.

■ Cleaning Your Camera

- Use a blower brush to remove any dust on the lens, or LCD monitor and then gently wipe the camera with a soft, dry cloth. If any soil remains, apply a small amount of lens cleaning liquid to a piece of FUJIFILM lens cleaning paper and wipe gently.
- Do not scratch hard objects against the lens, or LCD monitor.
- Clean the body of the camera with a soft, dry cloth. Do not use volatile substances or cleaning products these items can cause damage.

■ Using the Camera When Traveling

When traveling overseas, do not place your camera in the check-in baggage. Baggage can be subjected to violent shocks, and the camera may be damaged inside or outside.

Power Supply and Batteries

Applicable Batteries

- In the camera, use AA-size alkaline or Ni-MH (nickel-metal hydride) rechargeable batteries. Do not use AA-size manganese or nickel-cadmium (Ni-Cd) batteries in your FinePix A700 because the heat created by the batteries could damage the camera or cause it not to work.
- The life of alkaline batteries varies between brands. The life of batteries you purchase may be shorter than those provided with the camera.

Notes on the Batteries

Incorrect use of the batteries could cause them to leak, become hot, ignite, or burst. Always observe the precautions given below.

- Do not heat the batteries or throw them into a fire.
- Do not carry or store batteries with metal objects such as necklaces or hairpins.
- Do not expose the batteries to water, and keep batteries from getting wet or stored in moist locations.
- Do not attempt to take apart or change the batteries, including battery casings.
- Do not subject the batteries to strong impacts.
- Do not use batteries that are leaking, deformed, discolored.
- Do not store batteries in warm or humid places.
- Keep the batteries out of reach of babies and small children.
- Make sure that the battery polarity (\oplus and \ominus) is correct.
- Do not use new with used batteries. Do not use charged and discharged batteries together.
- Do not use different types or brands of batteries at the same time.

- If you do not intend to use the camera for a long period of time, remove the batteries from the camera. Note if the camera is left with the batteries removed, the time and date settings are cleared.
- The batteries feel warm right after being used. Before removing the batteries, turn the camera off and wait for the batteries to cool down.
- Since batteries do not work well in cold weather or locations, warm the batteries by placing them inside your garments before use. Batteries do not work well when cold. They will work again when the temperature returns to normal.
- Soil (such as fingerprints) on the battery terminals makes the batteries charge less reducing the number of images. Carefully wipe the battery terminals with a soft dry cloth before loading.



If any liquid at all leaks from the batteries, wipe the battery compartment thoroughly and then load new batteries.



If any battery fluid comes into contact with your hands or clothing, flush the area thoroughly with water. Note that battery fluid can cause loss of eyesight if it gets into your eyes. If this occurs, do not rub your eyes. Flush the fluid out with clean water and contact your physician for treatment.

Using the AA-size Ni-MH batteries correctly

- As a power source in digital cameras, AA-size Ni-MH batteries (referred to hereafter as Ni-MH batteries) are superior to alkaline batteries in several ways, such as allowing more shots to be taken with the camera. However, care must be taken with the way Ni-MH batteries are used if their original performance is to be maintained.
- Ni-MH batteries left unused in storage for long periods can become “deactivated”. Also, repeatedly charging Ni-MH batteries that are only partially discharged can cause them to suffer from the “memory effect”. Ni-MH batteries that are “deactivated” or affected by “memory” suffer from the problem of only providing power for a short time after being charged. To prevent this problem, discharge and recharge them several times using the camera’s “Discharging rechargeable batteries” function. By repeating this cycle several times, the temporary reduction in performance caused by “memory” or “deactivation” can be remedied and the batteries can be restored to their original performance levels.

Deactivation and memory are specific to Ni-MH batteries and are not in fact battery faults. See p.100-101 for the procedure for “Discharging rechargeable batteries”.

CAUTION

Do not use the “Discharging rechargeable batteries” function when alkaline batteries being used.

- To charge Ni-MH batteries, use the quick battery charger (sold separately). Refer to the instructions supplied with the charger to make sure that the charger is used correctly.
- Do not use the battery charger to charge other batteries.
- Note that the batteries feel warm after being charged.
- Due to the way the camera is constructed, a small amount of current is used even when the camera is turned off. Note in particular that leaving Ni-MH batteries in the camera for a long period will overdischarge the batteries and may render them unusable even after recharging.
- Ni-MH batteries will self-discharge even when not used, and the time for which they can be used may be shortened as a result.
- Ni-MH batteries will deteriorate rapidly if overdischarged (e.g. by discharging the batteries in a flashlight). Use the “Discharging rechargeable batteries” function provided in the camera to discharge the batteries.
- Ni-MH batteries have a limited service life. If a battery can only be used for a short time even after repeated discharge-charge cycles, it may have reached the end of its service life.

Disposing of Batteries

When disposing of batteries, do so in accordance with your local waste disposal regulations.

AC Power Adapter

Always use the AC Power Adapter AC-3VX with the camera.

The use of an AC power adapter other than AC-3VX can be damaged to your digital camera.

- Use the AC power adapter for indoor use only.
- Plug the connection cord plug securely into the DC input terminal of the FUJIFILM Digital camera.
- Turn off the FUJIFILM Digital camera before disconnecting the cord from the FUJIFILM Digital camera's DC input terminal. To disconnect, pull out the plug gently. Do not pull on the cord.
- Do not use the AC power adapter with any device other than your camera.
- During use, the AC power adapter will become hot to the touch. This is normal.
- Do not take apart the AC power adapter. Doing so could be dangerous.
- Do not use the AC power adapter in a hot and humid place.
- Do not subject the AC power adapter to strong shocks.
- The AC power adapter may emit a humming. This is normal.
- If used near a radio, the AC power adapter may cause static. If this happens, move the camera away from the radio.



Discharging rechargeable batteries

The Discharging rechargeable batteries function can only be used with Ni-MH batteries.

The Discharging rechargeable batteries function should not be used with alkaline batteries as it will completely drain the battery charge.

Use the Discharging rechargeable batteries function in the following situations:

- When the batteries only last for a short time after being charged normally
- When the batteries have not been used for a long period
- When you purchase new Ni-MH batteries

Do not use the Discharging rechargeable batteries function while using the AC power adapter. In these situations, the Ni-MH batteries will not be discharged due to the external power supply.

To discharge rechargeable batteries:

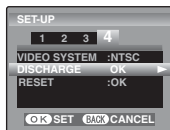



① Press  for about 1 second to turn the camera on.



MENU /OK
② Press MENU/OK to open the menu.



③ Press  or  to select **SET** OPTION.





④ Press  or  to select SET-UP.



MENU /OK
⑤ Press MENU/OK to open the SET-UP menu.



⑥ Press  or  to move to option 4.



⑦ Press  or  to select DISCHARGE.



⑧ Press .



MENU /OK
⑨ Press MENU/OK.



⑩ Press  or  to select OK.



MENU /OK
⑪ The screen changes and discharging begins. When the battery level indicator blinks red and discharging ends, the camera turns off.

 **CAUTION**

To cancel discharging, press DISP/BACK.

Notes on the xD-Picture Card™ and the Internal Memory

■ Image Memory Card

- This Image Memory Card is a new image recording media (**xD-Picture Card**) developed for digital cameras. The Image Memory Card consists of a semiconductor memory (NAND-type flash memory) to record digital image data. The recording process is electrically performed and enables erasure of existing image data as well as re-recording of new image data.
- When using a new Memory Card, or a Memory Card that has been formatted by a PC, be sure to format the card with your digital camera before using it.

■ Internal Memory

- Images held in the camera's internal memory may be corrupted or erased due to problems such as camera faults. Save your important data to another media (i.e., DVD-R, CD-R, CD-RW, hard disk, etc.).
- Data stored in the camera's internal memory cannot be guaranteed in the event that the camera is submitted for repairs.
- When the camera is repaired, any data stored in the camera's internal memory is subject to checking by the repairer.

■ Protecting Your Data

- Images and movies may be lost or destroyed in the following situations. Please note that FUJIFILM assumes no responsibility for data that is lost or destroyed.
 1. Removal of the memory card or turning the power off while the memory card or internal memory is being accessed (i.e., during record, erase, initialization, and playback operations).
 2. Improper handling and use of the memory card or internal memory by the user or third party.



MEMO

Save your important data to another media (i.e., DVD-R, CD-R, CD-RW, hard disk, etc.).

■ Handling xD-Picture Card

- When storing **xD-Picture Cards**, make sure that they are kept out of the reach of children. An **xD-Picture Card** could be swallowed cause suffocation. If a child swallows an **xD-Picture Card**, seek medical attention or call emergency number right away.
- When inserting the **xD-Picture Card** into the camera, hold the **xD-Picture Card** straight as you push it in.
- Do not expose an **xD-Picture Card** to shock. Do not apply pressure, and avoid bending.
- Do not use or store **xD-Picture Card** in hot and humid places.
- Clean the **xD-Picture Card** with a soft dry piece of cloth when dirty.
- When carrying or storing an **xD-Picture Card**, keep it in the special protective case.
- The **xD-Picture Card** will work well for long time, but will sooner or later lose its ability to store and play back images or movies. If this happens replace it with a new **xD-Picture Card**.
- Never remove the **xD-Picture Card** or turn the camera off during data recording or erasing (**xD-Picture Card** formatting) as this could be damaged to the **xD-Picture Card**.
- The use of **xD-Picture Cards** is recommended with FinePix A700.

The recording quality cannot be guaranteed when **xD-Picture Cards** other than those manufactured by FUJIFILM are used.

- The **xD-Picture Card** may feel warm when it is removed from the camera after taking pictures. This is normal.
- Do not put labels on the **xD-Picture Card**. Peeling labels can cause the camera not to work properly.

MEMO

- There are two types of **xD-Picture Card**: standard type and Type M (containing “M” in the model number, such as DPC-M2GB).
FinePix A700 is compatible with Type M, however they may not be compatible depending on the device used (Image Memory Card Reader, etc.).
- While Type H and M share the same compatibility, Type H cannot be used with **xD-Picture Card** USB drive DPC-UD1, while Type M can.

■ Using **xD-Picture Card** or Internal Memory with a PC





- When taking pictures using an **xD-Picture Card** or internal memory that has been used on a PC, reformat the **xD-Picture Card** or internal memory using your camera for best quality.
- When formatting an **xD-Picture Card** or internal memory, a directory (folder) is created. Image data is then recorded in this directory.
- Do not change or delete the directory (folder) or file names on the **xD-Picture Card** or internal memory because this will make it impossible to use the **xD-Picture Card** or internal memory in your camera.
- Always use the camera to erase image data on an **xD-Picture Card** or internal memory.
- To edit image data, copy or transfer the image data to the PC and edit the copied or transferred data.



■ Specifications

Type	Image memory card for digital cameras (xD-Picture Card)
Memory type	NAND-type flash memory
Conditions for use	Temperature: 0°C to +40°C (+32°F to +104°F) Humidity: 80% max. (no condensation)
Dimensions	25 mm × 20 mm × 2.2 mm (0.98 in. × 0.79 in. × 0.09 in.) (W × H × D)





Warning Displays

The table below lists the warnings that are displayed on the LCD monitor.

Warning Displayed	Explanation	Remedy
 (Lit red)  (Blinking red)	The batteries are low or completely out of charge.	Load new or fully charged batteries.
	There is a strong likelihood of camera shake because the shutter speed is slow.	Use flash photography. A tripod may be recommended, depending on the scene and mode.
	The AF (autofocus) cannot work effectively.	<ul style="list-style-type: none"> • If the image is too dark, take the picture at a distance of around 2 m (6.6 ft.) from the subject. • Use AF lock to take the picture (→p.28). • Select Macro mode when taking close-up shots.
	The camera cannot shoot the picture at the correct brightness due to too bright or dark shooting condition.	The picture can be taken, but the correct brightness (exposure) will not be obtained.
FOCUS ERROR ZOOM ERROR	Camera malfunction or fault.	<ul style="list-style-type: none"> • Turn the camera on again, taking care not to touch the lens. • Turn the camera off and on again. If the message still appears, contact your FUJIFILM dealer.
NO CARD	xD-Picture Card is not inserted when transferring images.	Insert an xD-Picture Card .
CARD NOT INITIALIZED	<ul style="list-style-type: none"> • The xD-Picture Card or internal memory is not formatted. • The xD-Picture Card contact area is soiled. • Camera fault. 	<ul style="list-style-type: none"> • Format the xD-Picture Card or internal memory on the camera (→p.73). • Wipe the contact area on the xD-Picture Card with a soft, dry cloth. It may be necessary to format the xD-Picture Card (→p.73). If the message still appears, replace the xD-Picture Card. • Contact your FUJIFILM dealer.

Warning Displayed	Explanation	Remedy
CARD ERROR	<ul style="list-style-type: none"> • The xD-Picture Card contact area is soiled. • The xD-Picture Card format is incorrect. • Camera fault. • The xD-Picture Card is damaged. 	<ul style="list-style-type: none"> • Wipe the contact area on the xD-Picture Card with a soft, dry cloth. It may be necessary to format the xD-Picture Card (→p.73). If the message still appears, replace the xD-Picture Card. • Contact your FUJIFILM dealer.
 MEMORY FULL  MEMORY FULL	The internal memory or xD-Picture Card is full.	Erase some images in internal memory or xD-Picture Card (→p.34), or use an xD-Picture Card that has ample free space.
WRITE ERROR	<ul style="list-style-type: none"> • The data could not be recorded due to an xD-Picture Card error or a connection error between the xD-Picture Card and camera. • The image cannot be recorded as it is too large to fit in the available space on the xD-Picture Card. • The xD-Picture Card or internal memory is not formatted. 	<ul style="list-style-type: none"> • Re-insert the xD-Picture Card or turn the camera off and then on again. If the message still appears, contact your FUJIFILM dealer. • Use a new xD-Picture Card. • Format the xD-Picture Card or internal memory on the camera (→p.73).
BUSY	The timing for recording was incorrect because the xD-Picture Card was formatted on a PC.	Use an xD-Picture Card that was formatted on the camera.
FRAME NO. FULL	The frame number has reached 999-9999.	<ol style="list-style-type: none"> ① Insert a formatted xD-Picture Card into the camera. ② Set RENEW as the FRAME NO. setting in the SET SET-UP menu (→p.71). ③ Start taking pictures (The frame number starts from "100-0001"). ④ Set CONT. as the FRAME NO. setting in the SET SET-UP menu.
READ ERROR	<ul style="list-style-type: none"> • The played back file was not recorded correctly. • The xD-Picture Card contact area is soiled. • Camera fault. • An attempt was made to play back the image or the movie that was not recorded on this camera. 	<ul style="list-style-type: none"> • This file cannot be played back. • Wipe the contact area on the xD-Picture Card with a soft, dry cloth. It may be necessary to format the xD-Picture Card (→p.73). If the message still appears, replace the xD-Picture Card. • Contact your FUJIFILM dealer. • The movie and image cannot be played back.

Warning Displays

Warning Displayed	Explanation	Remedy
PROTECTED FRAME	<ul style="list-style-type: none"> • A protected file was encountered. • An attempt was made to add a voice memo to protected file. 	<ul style="list-style-type: none"> • Protected files cannot be erased. Remove the protection (→p.54). • Protected files cannot be added to voice memos. Remove the protection (→p.54).
 ERROR	<ul style="list-style-type: none"> • The voice memo file is faulty. • Camera fault. 	<ul style="list-style-type: none"> • The voice memo cannot be played back. • Contact your FUJIFILM dealer.
 NO IMAGE  NO IMAGE	An attempt was made to transfer images from the xD-Picture card or internal memory that memory was empty.	It is impossible to copy.
 CAN NOT TRIM	An attempt was made to trim a 0.3M image.	The image cannot be trimmed.
CAN NOT TRIM	<ul style="list-style-type: none"> • An attempt was made to trim an image shot using a camera other than FinePix A700. • The image is damaged. 	The image cannot be trimmed.
DPOF FILE ERROR	Prints were specified for 1000 or more frames in the DPOF frame settings.	The maximum number of frames for which prints can be specified on the same xD-Picture Card is 999. Copy the images for which you want to order prints onto another xD-Picture Card and then specify the DPOF settings.
CAN NOT SET DPOF  CAN NOT SET DPOF	An attempt was made to specify DPOF settings for an image that is not supported by DPOF.	DPOF printing cannot be used with this image format.
COMMUNICATION ERROR	The camera is not connected to a PC or printer.	<ul style="list-style-type: none"> • Check that the USB cable (mini-B) is connected correctly. • Check that your printer is turned on.

Warning Displayed	Explanation	Remedy
PRINTER ERROR	Displayed for PictBridge.	<ul style="list-style-type: none"> • Check that the printer is not out of paper or out of ink. • Turn the printer off briefly and then turn it back on. • Refer to the user manual supplied with your printer.
PRINTER ERROR RESUME?	Displayed for PictBridge.	Check that the printer is not out of paper or out of ink. Printing automatically restarts when the error is cleared. If the message still appears after checking, press MENU/OK to restart printing.
CANNOT BE PRINTED	Displayed for PictBridge.	<ul style="list-style-type: none"> • Refer to the user manual for the printer being used and check whether the printer supports the JFIF-JPEG or Exif-JPEG image format. If not, the printer cannot print the images. • Movie images cannot be printed. • Was the image data photographed using FinePix A700? <p>You may not be able to print some images photographed on other cameras.</p>

Troubleshooting

■ Getting ready

Matters	Problems	Possible causes	Solutions	Page
Batteries and power supply	Nothing happens when pressing POWER.	The batteries have run out.	Load new or fully charged batteries.	14, 16, 98
		The batteries are loaded backward.	Load the batteries in the correct direction.	15
		The battery cover is not closed securely.	Close the battery cover securely.	15
		The camera and AC power adapter are not connected correctly.	Connect the camera and AC power adapter correctly.	76, 100
	Batteries run out quickly.	Camera is used in extremely cold conditions.	Put the batteries in your pocket or another warm place to heat it and then load it into the camera just before you take a picture.	14, 16, 98
		The terminals are soiled.	Wipe the battery terminals with a clean, dry cloth.	16, 98
		Same batteries have been used for a long period.	The batteries can no longer be recharged. Load new or fully charged batteries.	14, 16, 98
	Power cuts out during operation.	The rechargeable batteries (if used) have become deactivated, or the battery capacity has diminished due to the memory effect.	Use the rechargeable battery discharging function to restore the rechargeable batteries to full capacity.	100
		The batteries have run out.	Load new or fully charged batteries.	14, 16, 98
		The AC power adapter plug has come out of the power outlet.	Plug the adapter back in.	76, 100

■ Setting menu etc.





Matters	Problems	Possible causes	Solutions	Page
LCD monitor display	Screens are not displayed in English.	A language other than English is selected in the 言語/LANG. setting in the SET-UP menu.	Select ENGLISH.	23

■ Shooting

Matters	Problems	Possible causes	Solutions	Page
Basic operations	No photograph is taken when pressing the shutter button.	The xD-Picture Card or internal memory is full.	Insert a new xD-Picture Card or erase some unnecessary frames.	17, 34
		The xD-Picture Card or internal memory is not formatted.	Format the xD-Picture Card or internal memory on the camera.	68, 73
		The xD-Picture Card contact area is soiled.	Wipe the xD-Picture Card contact area with a soft, dry cloth.	17, 102
		The xD-Picture Card is damaged.	Insert a new xD-Picture Card .	17
		The batteries have run out.	Load new or fully charged batteries.	14, 16, 98
	The Auto power off function has turned the camera off.	Turn the camera on.	19	
	The LCD monitor darkens after taking a picture.	You took pictures with flash.	The LCD monitor may darken for charging flash. Wait a short time.	42
Focusing	Camera has difficulty in focusing on the subject.	You took a close-up shot without selecting Macro mode.	Select Macro mode.	40
		You photographed scenery with Macro mode selected.	Cancel Macro mode.	40
		You are shooting a subject that is not suited to autofocus (→p.29).	Use AF/AE lock to take the picture.	28

Continued ➔

■ Shooting







Matters	Problems	Possible causes	Solutions	Page
Flash	Cannot use the flash.	The shutter button was pressed while the flash was charging.	Wait until the charging is completed before pressing the shutter button.	42
		The Shooting mode is set to ▲.	Change the Shooting mode.	38
		The batteries have run out.	Load new or fully charged batteries.	14, 16, 98
	The flash settings are restricted and cannot be selected.	The Shooting mode is set to  ,  ,  , or  .	The flash settings are restricted because the camera settings are tailored to the scene being shot. Change the Shooting mode for a wider range of flash settings.	38
	The playback image is dark even though the flash was used.	The subject is too far away.	Move to within the effective flash range before taking the picture.	40, 42
		Your finger was covering the flash.	Hold the camera correctly.	24
Photographed images	The image is blurred.	The lens is dirty.	Clean the lens.	97
		!AF appeared when taking pictures.	Check the focus on the subject and take pictures.	25, 28, 104
		!📷 appeared when taking pictures.	It may cause camera shake. Hold the camera steadily.	26, 104
	There is speckling on the image.	The picture was taken with a slow shutter speed (long exposure) in a high-temperature environment.	This is a characteristic of CCDs and does not indicate a camera fault.	—
Recording images	Photographed images or movies are not recorded.	AC power adapter was connected or disconnected during turning the camera on.	Connect or disconnect the AC power adapter only when the camera is off. Failing to turn the camera off first can result in damage to the xD-Picture Card or malfunctions during PC connection.	88, 100

■ Playing back

Matters	Problems	Possible causes	Solutions	Page
Playing back movie / voice memo	The camera does not emit any sound.	The camera volume is set too low.	Adjust the volume.	67
		The microphone was blocked during shooting/recording.	Take care not to block the microphone during shooting/recording.	58, 64
		There is something covering the speaker during playback.	Make sure that the speaker is uncovered.	60, 66
Erasing	Erasing FRAME does not erase the frame.	Some frames may be protected.	Unprotect frames using the camera on which the protection was first applied.	54
	Erasing ALL FRAMES does not erase all the frames.			
Frame No.	CONT. in the frame number setting does not function.	You opened the battery cover without turning the camera off when replacing the batteries or xD-Picture Card .	Always turn the camera off when replacing the batteries or xD-Picture Card . Opening the battery cover without turning the camera off may cause the frame number memory to not function.	19

Continued ➔





■ Connecting





Matters	Problems	Possible causes	Solutions	Page
Connecting to TV	There is no image or sound on the TV.	The camera is not connected to the TV correctly.	Connect the camera and TV correctly.	76
		The included A/V (audio/visual) cable was connected during movie playback.	After the movie playback mode is stopped, connect the camera and TV correctly.	66, 76
		"TV" is selected as the TV input.	Set the TV input to "VIDEO".	76
		The video output setting is incorrect.	Change the setting to NTSC or PAL.	68, 70
		The TV volume is turned down.	Adjust the volume.	76
	The TV image is black and white.	The video output setting is incorrect.	Change the setting to NTSC or PAL.	68, 70
Connecting to PC	PC does not recognize the camera.	The USB cable (mini-B) is not correctly connected to the PC or camera.	Set up the camera, and connect the USB cable (mini-B) correctly.	88
		 ⇌ PICTBRIDGE is selected in  ⇌ USB MODE in the SET-UP menu.	Perform the below steps to cancel the setting before selecting  ⇌ DSC. <ul style="list-style-type: none"> • Windows <ol style="list-style-type: none"> ① The "New Hardware Found" wizard or "Scanner and Camera" wizard appears. If the wizard does not appear, proceed to step ③. ② Click the [Cancel] button. ③ Disconnect the camera from the PC. • Macintosh <ol style="list-style-type: none"> ① The window for locating the driver appears. If the window does not appear, proceed to step ③. ② Click the [Cancel] button. ③ Disconnect the camera from the Macintosh. 	88
Connecting to printer	Cannot print with PictBridge.	 ⇌ DSC is selected in  ⇌ USB MODE in the SET-UP menu.	Select  ⇌ PICTBRIDGE.	77

■ Others

Matters	Problems	Possible causes	Solutions	Page
Camera operation etc.	Nothing happens when pressing the buttons on the camera.	Camera malfunction may be caused temporarily.	Briefly remove the batteries or disconnect the AC power adapter. Then reload the batteries or reconnect the AC power adapter and try again.	14, 15, 76, 100
		The batteries have run out.	Load new or fully charged batteries.	14, 16, 98
	The camera no longer works correctly.	Camera malfunction may be caused temporarily.	Briefly remove the batteries or disconnect the AC power adapter. Then reload the batteries or reconnect the AC power adapter and try again. If you think the camera is faulty, contact your FUJIFILM dealer.	14, 15, 76, 100

Specifications

System	
Model	Digital camera FinePix A700
Effective pixels	7.28 million pixels
CCD	1/1.6-inch Super CCD HR
Storage media	Internal memory (approx. 12 MB) / xD-Picture Card (16/32/64/128/256/512 MB/1 GB/2 GB)
File format	Still image: DCF-compliant Compressed: Exif ver.2.2 JPEG, DPOF-compatible *Design rule for Camera File System compliant DPOF compatible Movie: AVI format, Motion JPEG Audio: WAVE format, Monaural sound
Number of recorded pixels	Still image: 3072 × 2304 pixels/3264 × 2176 pixels/2304 × 1728 pixels/1600 × 1200 pixels/640 × 480 pixels (7M / 3.2M / 4M / 2M / 6M)
File size	See the table on p.117
Lens	Fujinon 3x optical zoom lens F2.8-F5.2
Focal length	f=8.0 mm-24.0 mm (Equivalent to approx. 36 mm-108 mm on a 35 mm camera)
Digital zoom	Approx. 6.3x (3x optical zoom lens is used together: Max. zoom scale: approx. 18.9x) 3.2 :Approx. 5.4x (3x optical zoom lens is used together: Max. zoom scale: approx. 16.2x)
Aperture (Wide-angle)	F2.8/F8
Focal range	Normal: approx. 50 cm (1.6 ft.) to infinity Macro: Wide-angle: approx. 10 cm (3.9 in.) to 80 cm (2.6 ft.) Telephoto: approx. 35 cm (1.1 ft.) to 80 cm (2.6 ft.)
Sensitivity	AUTO/Equivalent to ISO 100/200/400
Photometry	TTL 64-zones metering Multi
Exposure control	Program AE
Scene position	 (PORTRAIT),  (LANDSCAPE),  (SPORT),  (NIGHT)
Exposure compensation	-2 EV to +2 EV in 1/3 EV-step increments (CM)

System	
Shutter speed	2 sec. to 1/1600 sec. (depend on Exposure mode)
Focus	Mode: Single-AF AF system: TTL contrast-type AF frame selection: AF (CENTER)
White balance	Automatic scene recognition/Presets (Fine, Shade, Fluorescent (Daylight), Fluorescent (Warm White), Fluorescent (Cool White), Incandescent)
Self-timer	Approx. 2 sec./10 sec.
Flash type	Auto flash Effective range: ( AUTO): Wide-angle: approx. 50 cm-3.8 m (1.6 ft.-12.5 ft.) Telephoto: approx. 60 cm-2 m (2.0 ft.-6.6 ft.) Macro: approx. 30 cm-80 cm (1.0 ft.-2.6 ft.)
Flash mode	Auto, Red-eye Reduction, Forced Flash, Suppressed Flash, Slow Synchro, Red-eye Reduction + Slow Synchro
LCD monitor	2.4 inches, Aspect ratio: 4:3; 112,000 pixels Amorphous silicon TFT, Approx. 91% coverage
Movie	320 × 240 pixels/160 × 120 pixels ( / ) (10 frames per second with monaural sound) A series of continuous image can be recorded up to 60 seconds (when setting ) / 180 seconds (when setting ). Zoom cannot be used during movie recording.
Photography functions	Best framing, Frame No. memory
Playback functions	Trimming, Automatic playback, Multi-frame playback, Voice memo
Other functions	PictBridge, Exif print, Language (English, Français, Deutsch, Español, Italiano, 中文簡, 繁體, 한글, Русский, Português, Nederlands, Türkçe), Time difference, Discharging rechargeable batteries

Continued ➔

Input/Output Terminal

A/V OUT (Audio/Visual output) NTSC/PAL-type (with monaural sound)

Digital input/output USB

DC input socket AC Power Adapter AC-3VX (sold separately)

Power Supply and Others

Power supply Use one of the following:

- 2×AA-size alkaline batteries
- 2×AA-size Ni-MH (Nickel-Metal Hydride) batteries (sold separately)
- AC power adapter AC-3VX (sold separately)

Guide to the number of available frames for battery operation

Battery Type	Number of frames
Alkaline batteries	Approx. 100 frames
Ni-MH batteries 2500 mAh	Approx. 300 frames

According to the CIPA (Camera & Imaging Products Association) standard procedure for measuring digital still camera battery consumption (extract):

When using alkaline batteries, use the batteries supplied with the camera. You can use Ni-MH batteries also. The storage media should be **xD-Picture Card**.

Pictures should be taken at a temperature of +23°C (+73°F), with the LCD monitor turned on, the optical zoom moved from full wide-angle to full telephoto (or vice-versa) and back again to its original position every 30 seconds, the flash used at full power every second shot and the camera turned off and then on again once every 10 shots.

- Note: Because the number of available shots varies depending on the capacity of alkaline batteries or the level of charge in Ni-MH batteries, the figures shown here for the number of available shots using batteries are not guaranteed.

The number of available shots will also decline at low temperatures.

Camera dimensions (W/H/D) 93.0 mm × 60.0 mm × 30.1 mm/3.7 in. × 2.4 in. × 1.2 in. (not including accessories and attachments)

Camera mass (weight) Approx. 139 g/4.9 oz. (not including accessories, batteries and **xD-Picture Card**)

Weight for photography Approx. 187 g/6.6 oz. (including batteries and **xD-Picture Card**)

Operating Conditions Temperature: 0°C to +40°C (+32°F to +104°F)
80% humidity or less (no condensation)

■ Standard number of available frames/recording time per **xD-Picture Card** and internal memory

The number of available frames, recording time or file size varies slightly depending on the subjects photographed. Note also that the divergence between standard number of frames and the actual number of frames is greater for **xD-Picture Cards** with higher capacities.

Quality setting	7M F	7M N	3:2	4M	2M	3M	320 (10 fps)	160 (10 fps)
Number of recorded pixels	3072 × 2304		3264 × 2176	2304 × 1728	1600 × 1200	640 × 480	320 × 240	160 × 120
Image data size	3.5 MB	1.7 MB	1.7 MB	984 KB	630 KB	130 KB	–	–
Internal memory (approx. 12 MB)	3	6	6	11	19	93	71 sec.	220 sec.
16 MB	4	8	8	15	25	122	94 sec.	288 sec.
32 MB	8	17	17	31	50	247	189 sec.	9.7 min.
64 MB	18	36	35	64	101	497	6.3 min.	19.4 min.
128 MB	36	72	72	128	204	997	12.7 min.	39.0 min.
256 MB	73	146	145	257	409	1997	25.5 min.	78.1 min.
512 MB	146	292	290	515	818	3993	51.0 min.	156.3 min.
1 GB	294	586	581	1031	1639	7995	102.1 min.	313.0 min.
2 GB	586	1162	1162	2063	3198	15992	204.3 min.	626.1 min.

If you shoot using the **xD-Picture Cards** with model numbers containing “M” such as DPC-M2GB, movie recording time may be reduced if you repeatedly record and erase (frame erase) image files. In such a case, erase all frames or format the **xD-Picture Card** before use. Back up important frames (files) onto your PC or another media.

- * These specifications are subject to change without notice. FUJIFILM shall not be held liable for damages resulting from errors in this Owner’s Manual.
- * The LCD monitor on your digital camera is manufactured using advanced high-precision technology. Even so, small bright points and anomalous colors (particularly around text) may appear on the monitor. These are normal display characteristics and do not indicate a fault with the monitor. This phenomenon will not appear on the recorded image.
- * The operation error may be caused in a digital camera by the strong radio interference (i. e. electric fields, static electricity, line noise, etc.).
- * Due to the nature of the lens, the edges of images may appear distorted. This is normal.

Explanation of Terms

Deactivated batteries

Leaving an Ni-MH battery unused in storage for a long period may cause a rise in the level of substances that inhibit current flow inside the battery and result in a dormant battery. A battery in this state is referred to as deactivated.

Because current flow is inhibited in a deactivated Ni-MH battery, the battery's original level of performance cannot be achieved.

EV

A number denotes Exposure Value. The EV is determined by the brightness of the subject and sensitivity (speed) of the film or CCD. The number is larger for bright subjects and smaller for dark subjects. As the brightness of the subject changes, a digital camera maintains the amount of light hitting the CCD at a constant level by adjusting the aperture and shutter speed. When the amount of light striking the CCD doubles, the EV increases by 1. Likewise, when the light is halved, the EV decreases by 1.

Frame rate (fps)

The frame rate refers to the number of images (frames) that are photographed or played back per second. For example, when 10 frames are continuously photographed in a 1-second interval, the frame rate is expressed as 10 fps.

For reference, TV images are displayed at 30 fps (NTSC).

JPEG

Joint Photographic Experts Group

A file format used for compressing and saving color images. The higher the compression rate, the greater the loss of quality in the decompressed (restored) image.

Memory effect

If an Ni-MH battery is repeatedly charged without first being fully discharged, its performance may drop below its original level. This is referred to as the "memory effect".

Motion JPEG

A type of AVI (Audio Video Interleave) file format that handles images and sound as a single file. Images in the file are recorded in JPEG format. Motion JPEG can be played back by QuickTime 3.0 or later.

Smear

A phenomenon specific to CCDs whereby white streaks appear on the image when there is a very strong light source, such as the sun or reflected sunlight, in the photography screen.

WAVE

A standard format used on Windows systems for saving audio data. WAVE files have the ".WAV" file extension and the data can be saved in either compressed or uncompressed format. Uncompressed recording is used on this camera.

WAVE files can be played back on a personal computer using the following software:

Windows: MediaPlayer

Macintosh: QuickTime Player * QuickTime 3.0 or later

White Balance

Whatever the kind of the light, the human eye adapts to it so that a white object still looks white. On the other hand, devices such as digital cameras see a white subject as white by first adjusting the color balance to suit the color of the ambient light around the subject. This adjustment is called matching the white balance.



Exif Print Format is a newly revised digital camera file format that contains a variety of shooting information for optimal printing.

FUJIFILM Digital Camera Worldwide Network

If you have technical questions or if you need repair service, ask the following local distributor.
Please present the warranty card and your purchase receipt when you ask for repairs. Refer to the warranty card for conditions of the warranty.
There is a case that repair and Technical support cannot be accepted for some models which your local distributor does not deal with.
These lists are subject to change without notice.

NORTH AMERICA		
Canada	Fuji Photo Film Canada Inc. Technical support Repair service	600 Suffolk Court Mississauga Ontario, L5R 4G4 TEL 1-866-818-FUJI (3854) http://www.fujihelp.ca 600 Suffolk Court Mississauga Ontario, L5R 4G4 TEL 1-800-263-5018 FAX 1-905-755-2993 http://www.fujihelp.ca
U.S.A.	Fuji Photo Film USA Technical support Repair service	1100 King George Post Rd., Edison, NJ 08837 TEL 800-800-3854 FAX 732-857-3487 digitalinfo@fujifilm.com 1100 King George Post Rd., Edison, NJ 08837 TEL 732-857-3000 FAX 732-857-3471 njcamerarepair@fujifilm.com
Hawaii	Fuji Photo Film Hawaii, Inc. Technical support & Repair service	94-468 Akoki Street, Waipahu, HI. 96797 TEL 1-808-677-3854, ext. 209 FAX 1-808-677-1443 kurt_kmett@fujifilmhawaii.com
CENTRAL & SOUTH AMERICA		
Argentina	Imagen e informacion S.A. Technical support & Repair service	Fondo de la Legua 936 San Isidro Pcia. de Buenos Aires TEL +54-11-4836-1000 FAX +54-11-4836-1144 servtec@imageneinformacion.com.ar
Bolivia	Reifschneider Bolivia Ltda. Technical support & Repair service	Calle H N.º 5 - Equipetrol Norte - Santa Cruz TEL +591 33 44 1129 FAX +591 33 45 2919 gciagral@bibosi.scz.entelnet.bo
Brazil	Fuji Photo Film do Brasil Ltda. Technical support & Repair service	Av. Vereador José Diniz, 3400 - Campo Belo, São Paulo/SP TEL 0800-12-8600 FAX +55 11 5091-4150 camarasdigitais@fujifilm.com.br
Chile	Reifschneider SA Technical support & Repair service	Av. El Conquistador del Monte 5024, Huechuraba, Santiago, Chile TEL 02-4431500 FAX 02-4431596 ceciliacalvo@reifschneider.cl
Colombia	Animex de Colombia Ltda. Technical support & Repair service	Calle 44 N.º 13-43 Piso 2 Apartado 18001 - Bogotá TEL +57 1 338-0299 FAX +57 1 288-2208 animex@etb.net.co
Ecuador	Espacri Cia Ltda Technical support & Repair service	Bolívar 5-69 y Hermano Miguel TEL 593-72-835526 FAX 593-72-833157

Ecuador	Importaciones Espacri Cia. Ltda. Technical support & Repair service	Simón Bolívar 5-69 y Hno. Miguel - Cuenca TEL +593 783 5526 FAX +593 783 3157 portiz@fujifilm.com.ec
Mexico	Fujifilm de Mexico, S.A. de C.V. Technical support Repair service	Av. Ejercito Nacional 351, Col. Granada 11520 Mexico, D.F. TEL (52-55) 5263-5566 / 68 FAX (52-55) 5254-1508 jlgiraud1@fujifilm.com.mx Av. Presidente Juarez 2007, Col. Tepetlalcálco, 54090 Tlalne-pantla, Edo. de Mexico TEL (52-55) 5263-5500 FAX (52-55) 5254-1508 jlgiraud1@fujifilm.com.mx
Paraguay	Errece S.R.L. Technical support & Repair service	Edificio Unitas 15 de Agosto 1035, Asunción TEL +595 21 444256 FAX +595 21 444651 jmarbulo@fujifilm.com.py
Peru	Procesos de Color S.A. Technical support & Repair service	Pablo Bermudez 111 Apartado 3794 - Esq. Arequipa - Lima 11 TEL +51 14 33 5563 FAX +51 14 33 7177 jalvarado@fujifilm.com.pe
Uruguay	Fotocamara S.R.L. Technical support & Repair service	Cuareim 1439, montevideo, Uruguay TEL +598-2-9002004 FAX +598-2-9008430 fotocam@adinet.com.uy
Uruguay	Kiel S.A. Technical support & Repair service	Maldonado 1787 Montevideo- Uruguay TEL (05982) 419 4542 FAX (05982) 412 0046 kiel@fujifilm.com.uy
Venezuela	C. Hellmund & Cia Sa Technical support & Repair service	Av. Ppal Diego Cisneros Caracas Venezuela Edf Oficentro TEL 0212-2022300 FAX 0212-2399796 hellmund@hellmund.com
EUROPE		
Austria	Fuji Film Oesterreich Technical support & Repair service	Traviatagasse/Pfarrgasse, 1230 Vienna, Austria TEL 0043 1 6162606/51 or 52 FAX 0043 1 6162606/58 kamera.service@fujifilm.at
Belgium	Belgian Fuji Agency Technical support & Repair service	20, Avenue Lavoisier, Wavre, 1300, Belgium TEL 3210242090 FAX 3210238562 info@fuji.be
Croatia	I&I d.o.o. Technical support Repair service	Hondlova 2, Zagreb, Croatia TEL 38512319060 FAX 2310240 dsaravanja@fujifilm.hr Hondlova 2, Zagreb, Croatia TEL 38512316228 FAX 2310240 info@fujifilm.hr

Continued ➔

FUJIFILM Digital Camera Worldwide Network

Cyprus	PMS IMAGING LTD Technical support & Repair service	11, Dighenis Akritis Avenue, P.O.BOX 22315, 1586 Nicosia TEL 35722746746 FAX 35722438209 mariosashiotis@fujifilm.com.cy
Cyprus	Doros Neophytou CAMERA REPAIRS Technical support & Repair service	28B, Agiou Demetriou, Acropoli, Nicosia TEL 35722314719 FAX 35722515562 dorosn@logosnet.cy.net
Czech Republic	Fujifilm Cz., s.r.o. Technical support	U nakladoveho nadrazi 2/1949, 130 00 Praha 3 TEL 00420 234 703 411 FAX 00420 234 703 489 fricman@fujifilm.cz
Czech Republic	AWH servis Repair service	Milesovska 1, 130 00 Praha 3, Czech republic TEL 00420 222 721 525 FAX 00420 222 720 122 awh@awh.cz
Denmark	Fujifilm Denmark A/S Technical support & Repair service	Stubbeled 2, 2950 Vedbæk Denmark TEL 0045 45662244 FAX 0045 45662214 fujifilm@fujifilm.dk
Finland	Fuji Finland Oy Technical support & Repair service	Martinkyläntie 41, 01720 Vantaa, Finland TEL +358 9 825951 FAX +358 9 870 3818 fuji@fuji.fi
France	FUJIFILM France Technical support & Repair service	2, Avenue Franklin, 78186 Saint-Quentin en Yvelines, France FAX 33 1 01 30 58 58 65 direction.technique@fujifilm.fr
Germany	Fuji Photo Film (Europe) GmbH Technical support & Repair service	Heesenstr. 70, 40549 Düsseldorf International call TEL +49 211 50890 FAX +49 211 5089668 service@fujifilm.de National call* TEL 0180 5898980 FAX 0180 5898982 *12 Cent/Min aus dem deutschen Festnetz
Greece	FUJIFILM HELLAS S.A. Technical support & Repair service	1, Iliou & Ag. Anargiron str., 175 64 P.Phailro, Athens, Greece TEL 0030 210 9404100 FAX 0030 210 9404397 fujifilm@fujifilm.gr
Hungary	Fujifilm Hungary Ltd. Technical support	Váci ut 19. Budapest, 1134, Hungary TEL 3612389410 FAX 3612389401 fujifilm@fujifilm.hu
Iceland	Icephoto (Ljosmyndavörur) Technical support & Repair service	Skipholt 31, 105 Reykjavik, Iceland TEL 354 568 0450 FAX 354 568 0455 framkollun@fujifilm.is
Italy	FujiFilm Italia S.p.A. Technical support Repair service	Via Dell'Unione Europea, 4 - 20097 San Donato Milanese (MI), Italy TEL 039-02895821 FAX 039-0289582912 info@fujifilm.it Fujifilm On Line - Call center TEL 039-026695272 info@fujifilm.it

Lithuania	Fujifilm Lithuania Technical support & Repair service	Gerosios Vilties str. 38, LT-03143 Vilnius, Lithuania TEL 370-5-2130121 FAX 3705-5-2134066 info@fujifilm.lt
Malta	Ciancio (1913) Co.Ltd. Technical support & Repair service	Fuji Tech Centre, Ciancio House, Cannon Road, Qormi, QRM05 TEL 0356-21-480500 FAX 0356-21-488328 info@fujifilm.com.mt
Netherlands	Fujifilm Nederland BV Technical support Repair service	Hoogstraat 39, 3011 PE, Rotterdam, The Netherlands TEL 010-2812345 FAX 010-2812334 fuji@fujifilm.nl Hoevenseweg 43, 4877 LA, Etten-Leur, The Netherlands TEL 010-2812345 FAX 076-7502641 reparatie@fujifilm.nl
Norway	Fujifilm Norge AS Technical support Repair service	Lilleakerveien 10, 0283 Oslo, Norway TEL 0047-22736000 FAX 0047-22736020 http://www.fujifilm.no/ mailto:post@fujifilm.no Liaveien 1, 5132 Nyborg, Norway TEL 0047-55393880 FAX 0047-55195201 http://www.camera.no/ mailto:service@camera.no
Poland	Fujifilm Polska Distribution Sp. z o.o. Technical support Repair service	Poland Al..Jerozolimskie 178; 02-486 Warszawa TEL +48-22-517-66-00 FAX +48-22-517-66-02 fujifilm@fujifilm.pl Poland, Muszkieterow 15, 02-273 Warszawa TEL +48-22-886-94-40 FAX +48-22-886-94-42 serwis@fujifilm.pl
Portugal	Fujifilm Portugal, Lda Technical support Repair service	Av. Fontes Pereira de Melo, 342, 4100-259 Porto, Portugal TEL (351) 226194200 FAX (351) 226194213 finepix@fujifilm.pt Av. Fontes Pereira de Melo, 342, 4100-259 Porto, Portugal TEL (351) 226194200 FAX (351) 225194662 cameras@fujifilm.pt
Romania	CTS-Cardinal Top Systems Ltd Technical support & Repair service	112, Calea Dorobanti street, 4 flat, 1sector, Bucharest, Romania TEL 4021-230-09-82 FAX 4021-230-09-82 cts_tirla@hotmail.com
Russia	ZAO "Fujifilm RU" Technical support Repair service	Bld. 1, 10, Rozanova str., Moscow, 123007, Russia TEL +7-095-956-9858 FAX +7-095-230-6217 info@fujifilm.ru 18, Shelepikhinskaya Naberezhnaya str., Moscow, 123290, Russia TEL +7-095-797-3434 FAX +7-095-797-3434
Slovakia	Fujifilm Slovakia Technical support Repair service	Pribylinska 2, 831 04 Bratislava, Slovakia TEL 00421 2 44 888 077 FAX 00421 2 44 889 300 fujifilm@fujifilm.sk FIS Tatracentrum, Hodzovo nam. 4 - Tatracentrum, 811 06 Bratislava, Slovakia TEL 00421 2 54 647 347 fis.tatracentrum@stonline.sk

FUJIFILM Digital Camera Worldwide Network

Spain	Fujifilm España S.A.	Aragón 180, 08011 Barcelona (España)
	Technical support	TEL 902012535 FAX 934515900 / 933230330 info@fujifilm.es
	Repair service	Aragón 180, 08011 Barcelona (España)
		TEL 934511515 FAX 934515900 / 933230330 tallersat@fujifilm.es
Sweden	Fujifilm Sverige AB	Sveavägen 167 104 35 Stockholm
	Technical support	TEL 46 8 506 141 70 FAX 46 8 506 142 09 kamera@fujifilm.se
	Repair service	Sveavägen 167 104 35 Stockholm
		TEL 46 8 506 513 54 FAX 46 8 506513 54 kameraverkstaden@fujifilm.se
Switzerland / Lichtenstein	Fujifilm (Switzerland) AG	Niederhaslistrasse 12, 8157 Dietlikon, Switzerland
	Technical support & Repair service	TEL +41 44 855 5154 FAX +41 44 855 5329 RepairCenter@fujifilm.ch
Turkey	Fujifilm Turkiye Sinfo A.S.	Fujifilm Plaza, Dereboyu Cad. 39 34660 Halkali, Istanbul, Turkey
	Technical support	TEL +90 212 696 5090 FAX +90 212 696 5009 csarp@fujifilm.com.tr
	Repair service	Fujifilm Plaza, Dereboyu Cad. 39 34660 Halkali, Istanbul, Turkey
		TEL +90 212 696 5090 FAX +90 212 696 5010 servis@fujifilm.com.tr
U.K.	Fuji Photo Film (UK) Ltd.	St Martins Way St Martins Business Centre Bedford MK42 0LF
	Technical support	TEL +44 (0)123 424 5383 FAX +44 (0)123 424 5285 fujitec@fuji.co.uk
	Repair service	St Martins Way St Martins Business Centre Bedford MK42 0LF
		TEL +44 (0)123 421 8388 FAX +44 (0)123 424 5285 fujitec@fuji.co.uk
Ukraine	Image Ukraine CJSC	12, Kontraktova ploschcha, Kyiv 04070, Ukraine
	Technical support & Repair service	TEL +380-44-4909075 FAX +380-44-4909076 d@fujifilm.ua
MIDDLE EAST		
Iran	Tehran Fuka Co.	229, "Fuji" Bldg., Mirdamad Blvd., Tehran 19189, Iran
	Technical support & Repair service	TEL (+98-21)2254810-19 FAX (+98-21)2221002 fuka@neda.net
Israel	Shimone Group Ltd.	Efal 33 keyriat Arie Petah Tikva 49130, Israel
	Technical support	TEL (+) 972 3 9250666 digital@fujifilm.co.il
	Repair service	Efal 33 keyriat Arie Petah Tikva 49130, Israel
		TEL (+) 972 3 9250666 FAX 972 3 9250699 khaim@shimone.com
Jordan	Grand Stores	Al- Abdali, Amman / Jordan
	Technical support & Repair service	TEL 009626-4646387 FAX 009626-4647542 gstores@go.com.jo
Qatar	Techno Blue	Blue Salon Bldg, 3rd Floor, Suhaim bin Hamad st, Al- Saad, Doha
	Technical support	TEL 00974 44 66 175 FAX 00974 44 79 053 prabu@techno-blue.com

Saudi Arabia	Emam Distribution Co. Ltd. Technical support	P.O. Box 1716, Jeddah 21441, Saudi Arabia TEL 96626978756 FAX 96626917036 service@fujifilm.com.sa
Syria	Film Trading Company Technical support Repair service	Al-Shahbandar P.O. Box:31180 Damascus SYRIA TEL + 963 11 2218049 FAX + 963 11 44673456 f.t.c@Net.SY Al-cheikh Taha P.O. Box: 6171 Aleppo SYRIA TEL + 963 21 4641903 FAX + 963 21 4641907 filmtradin@Net.SY
U.A.E.	Grand Stores Technical support & Repair service	P. O. Box 2144, Saleh Bin Lahej Building, Al Garhoud, Deira, Dubai TEL + 971-4-2823700 FAX + 971-4-2828382 photography@grandstores.ae
Yemen	Al-Haidary Trading Technical support Repair service	P.O.Box-2942 Haddah St. HTC, Sana'a, Yemen TEL 00967-1-503980 FAX 00967-1-503983 P.O.Box-2942 Haddah St. HTC, Sana'a, Yemen TEL 00967-1-503977 FAX 00967-1-503983
AFRICA		
Egypt	Foto Express Egypt Technical support & Repair service	426 Pyramids St., Giza, Egypt TEL (202) 7762062 FAX (202) 7760169 fotoegypt@access.com.eg
Kenya	Fuji Kenya Ltd Repair service	P.O.Box 41669-00100, Fuji Plaza, Chiromo Road, Nairobi, Kenya. TEL (254-20)4446265-8 FAX (254-20)4448515 / 7 info@fujifilm.co.ke
OCEANIA		
Australia	FUJIFILM Australia Pty Ltd Technical support Repair service	114 Old Pittwater Road, Brookvale, NSW, 2100, Australia TEL 1800 226 355 FAX +61 (2) 9938 1975 digital@fujifilm.com.au 114 Joynton Avenue, Zetland, NSW, 2017, Australia TEL 1800 226 355 FAX +61 (2) 9938 1975 digital@fujifilm.com.au
Fiji	Brijlal & Co. Ltd Technical support & Repair service	70-72 Cumming Street, Suva, Fiji TEL (679)3304133 FAX (679)3302777 kapadia@connect.com.fj
New Caledonia	Phocidis SARL Technical support & Repair service	58, rue Higginson - B.P.661 - 98845 TEL (00 687) 25-46-35 FAX (00 687) 28-66-70 phocidis@phocidis.nc
New Zealand	Fujifilm NZ Ltd Technical support & Repair service	Cnr William Pickering & Bush Road Albany, Auckland TEL +64-9-4140400 FAX +64-9-4140410 glenn.beaumont@fujifilm.co.nz
Papua New Guinea	Oceania PNG Limited Technical support	Section 15, Allotment 1, Reke St, Boroko NCD. PNG. Mail: PO Box 2167, Boroko NCD. PNG. TEL +675 3256411 FAX +675 3250311 oceania@daltron.com.pg

Continued ➔

FUJIFILM Digital Camera Worldwide Network

ASIA		
Hong Kong	Fuji Photo Products Co., Ltd. Technical support & Repair service	8/F., TSUEN WAN IND. CENTRE, 220 TEXACO RD., TSUEN WAN, HONG KONG TEL (852)2406 3287 FAX (852)2408 3130 rsd@chinafphoto.com.hk
Indonesia	PT Modern Photo Tbk Technical support & Repair service	Jl.Matraman Raya 12, Jakarta Timur 13150 TEL +62 021 2801000 FAX +62 021 8581620+62 021 2801012 kmr-srv@moderngroup.co.id
Malaysia	Fuji Photo Film (Malaysia) Sdn. Bhd. Technical support Repair service	Letter Box 1, Level 10, 11 & 12, Menara Axis, No 2, Jalan 51A/223, 46100 Petaling Jaya, Selangor Darul Ehsan, Malaysia TEL 603-79584700 FAX 603-79584110 digital@fujifilm.com.my Letter Box 1, Level 10, 11 & 12, Menara Axis, No 2, Jalan 51A/223, 46100 Petaling Jaya, Selangor Darul Ehsan, Malaysia TEL 603-79584700 FAX 603-79584110 technical@fujifilm.com.my
Philippines	YKL Development & Trdg. Corp. Technical support Repair service	24 Sto. Domingo St., Quezon City 1100, Philippines TEL 632-7436601-06 FAX 632-7324661 digital@yklcolor.com 24 Sto. Domingo St., Quezon City 1100, Philippines TEL 632-7436601-06 FAX 632-7324661 tech_services@yklcolor.com
Singapore	Fuji Photo Film Singapore Pte Ltd Technical support & Repair service	10 New Industrial Road Fujifilm Building Singapore 536201 TEL 65-6380 5557 FAX 65-6281 3594 service@fujifilm.com.sg
South Korea	Korea Fujifilm Co., Ltd. Technical support	30-1, Mukjeung-dong, Jung-gu, Seoul, Korea TEL +82-2-3282-7363 FAX +82-2-2269-7435 photo@fujifilm.co.kr
South Korea	Yonsan AS Center (Fujidigital) Repair service	#301, 3F, Jeonjaland, 16-9, Hangangro3-ga, Yongsan-gu, Seoul, Korea TEL +82-2-701-1472 FAX +82-2-718-1331 1bow@hanmail.net
South Korea	Kangnam AS Center (Digitalgallery) Repair service	2F, Hyeongin Tower, 23-2, Bangyi-dong, Songpa-gu, Seoul, Korea TEL +82-2-2203-1472 FAX +82-2-418-5572 nurijili@hanmail.net
South Korea	Busan AS Center (Digital-Sewon) Repair service	241-4, Bujeon-dong, Busanjin-gu, Busan, Korea TEL +82-51-806-1472 FAX +82-51-817-0083 merahan@yahoo.co.kr
Taiwan	Hung Chong Corp. Technical support & Repair service	No. 38, Min-Chuan E. Rd. Sec. 6, Taipei (114), Taiwan, R.O.C. TEL 886-2-6602-8988 FAX 886-2-2791-8647 dah@mail.hungchong.com.tw
Thailand	Fuji Photo Film (Thailand) Ltd. Technical support Repair service	388 SP Building, 8th Floor, Phayathai, Bangkok 10400 TEL +662-2730029 ext. 755 FAX +662-2730239 supaleark@fujifilm.co.th 388 SP Building, 8th Floor, Phayathai, Bangkok 10400 TEL +662-2730029 ext.761,762 FAX +662-2730239 warin@fujifilm.co.th

Safety Notes

- Make sure that you use your FinePix A700 camera correctly. Read these Safety Notes and your Owner's Manual carefully before use.
- After reading these Safety Notes, store them in a safe place.

About the Icons

The icons shown below are used in this document to indicate the severity of the injury or damage that can result if the information indicated by the icon is ignored and the product is used incorrectly as a result.



WARNING

This icon indicates that death or serious injury can result if the information is ignored.



CAUTION

This icon indicates that personal injury or material damage can result if the information is ignored.

The icons shown below are used to indicate the nature of the information which is to be observed.



Triangular icons tell you that this information requires attention ("important").



Circular icons with a diagonal bar tell you that the action indicated is prohibited ("Prohibited").



Filled circles with an exclamation mark tell you an action that must be performed ("Required").



WARNING

If a problem arises, turn the camera off, remove the batteries, disconnect and unplug the AC power adapter.

Continued use of the camera when it is emitting smoke, is emitting any unusual odor, or is in any other abnormal state can cause a fire or electric shock.

- Contact your FUJIFILM dealer.



Unplug from power socket.

Do not allow water or foreign objects to enter the camera.

If water or foreign objects get inside the camera, turn the camera off, remove the batteries and disconnect and unplug the AC power adapter.

Continued use of the camera can cause a fire or electric shock.

- Contact your FUJIFILM dealer.



Do not use the camera in the bathroom or shower.

This can cause a fire or electric shock.



Do not use in the bathroom or shower.







Never attempt to change or take apart the camera. (Never open the casing.) Do not use the camera when it has been dropped or the casing is damaged.





This can cause a fire or electric shock.

- Contact your FUJIFILM dealer.



Do not disassemble.

 WARNING	
<p>Do not change, heat or unduly twist or pull the connection cord and do not place heavy objects on the connection cord.</p> <p>These actions could damage the cord and cause a fire or electric shock.</p> <ul style="list-style-type: none"> • If the cord is damaged, contact your FUJIFILM dealer. 	
<p>Do not place the camera on an unstable surface.</p> <p>This can cause the camera to fall or tip over and cause injury.</p>	
<p>Never attempt to take pictures while in motion.</p> <p>Do not use the camera while you are walking or driving a vehicle. This can result in you falling down or being involved in a traffic accident.</p>	
<p>Do not touch any metal parts of the camera during a thunderstorm.</p> <p>This can cause an electric shock due to induced current from the lightning discharge.</p>	
<p>Do not use the batteries except as specified.</p> <p>Load the batteries with the ⊕ and ⊖ marks.</p>	

 WARNING	
<p>Do not heat, change or take apart the batteries.</p> <p>Do not drop or subject the batteries to impacts.</p> <p>Do not attempt to recharge lithium or alkaline batteries.</p> <p>Do not store the batteries with metallic products.</p> <p>Do not use chargers other than the specified model to charge the batteries.</p> <p>Any of these actions can cause the batteries to burst or leak and cause fire or injury as a result.</p>	
<p>Use only the batteries or AC power adapters specified for use with this camera.</p> <p>Do not use voltages other than the power supply voltage shown.</p> <p>The use of other power sources can cause a fire.</p>	
<p>If the battery leaks and fluid gets in contact with your eyes, skin or clothing. Flush the affected area with clean water and seek medical attention or call an emergency number right away.</p>	
<p>Do not use the charger to charge batteries other than those specified here.</p> <p>The charger is designed for Fujifilm HR-AA Ni-MH batteries. Using the charger to charge conventional batteries or other types of rechargeable batteries can cause the battery to leak fluid, overheat or burst.</p>	



WARNING

When discarding or storing batteries, cover the battery terminals with insulation tape.

Contact with other metallic objects or batteries could cause the batteries to ignite or burst.



Keep xD-Picture Cards out of the reach of small children.

Because **xD-Picture Cards** are small, they can be swallowed by children. Be sure to store **xD-Picture Cards** out of the reach of small children. If a child swallows an **xD-Picture Card**, seek medical attention or call an emergency number.



CAUTION

Do not use this camera in locations affected by oil fumes, steam, humidity or dust.

This can cause a fire or electric shock.



Do not leave this camera in places subject to extremely high temperatures.

Do not leave the camera in locations such as a sealed vehicle or in direct sunlight. This can cause a fire.



Keep out of the reach of small children.

This product could cause injury in the hands of a child.



Do not place heavy objects on the camera.

This can cause the heavy object to tip over or fall and cause injury.



Do not move the camera while the AC power adapter is still connected. Do not pull on the connection cord to disconnect the AC power adapter.

This can damage the power cord or cables and cause a fire or electric shock.



Do not use the AC power adapter when the plug is damaged or the plug socket connection is loose.







This could cause a fire or electric shock.



Do not cover or wrap the camera or the AC power adapter in a cloth or blanket.

This can cause heat to build up and distort the casing or cause a fire.



 CAUTION	
<p>When you are cleaning the camera or you do not plan to use the camera for an extended period, remove the batteries and disconnect and unplug the AC power adapter.</p> <p>Failure to do so can cause a fire or electric shock.</p>	
<p>When charging ends, unplug the charger from the power socket.</p> <p>Leaving the charger plugged into the power socket can cause a fire.</p>	
<p>Using a flash too close to a person's eyes may temporarily affect the eyesight.</p> <p>Take particular care when photographing infants and young children.</p>	
<p>When an xD-Picture Card is removed, the card could come out of the slot too quickly. Use your finger to hold it and gently release the card.</p>	
<p>Request regular internal testing and cleaning for your camera.</p> <p>Build-up of dust in your camera can cause a fire or electric shock.</p> <ul style="list-style-type: none"> • Contact your FUJIFILM dealer to request internal cleaning every 2 years. • Please note this is not a free of charge service. 	

FUJIFILM

FUJIFILM Corporation

26-30, Nishiazabu 2-chome, Minato-ku, Tokyo 106-8620, Japan

<http://www.fujifilm.com/products/digital/>