



Quick Reference Notes - **SCAN**

簡易操作 - **掃描**

ApeosPort® 2560 / 3560

CONTENTS

目錄

1	Scanning Procedure 掃描步驟	1
1.1	Loading Document 放置原稿	1
1.1.1	Document Feeder 自動送稿裝置	1
1.1.2	Document Glass 玻璃面板	1
1.2	Selecting Scan Location 選擇掃描貯存位置	2
2	Scanning Features 掃描選項	4
2.1	Scanning Color 色彩模式	4
2.2	2-Sided Scanning 雙面原稿輸送	5
2.3	Original Type 原稿類型	5
2.4	File Format 印出檔案格式	6
2.5	Resolution 掃描解析度	7
2.6	File Name 檔案名稱	7
3	Operations During Scanning 掃描期間的操作	8
3.1	Stop The Scan Job 停止掃描	8
4	Load the Next Document 放置下一份原稿	9
5	Special Features 特別功能	11
5.1	Previewing and Rotating the Scanned Images 預覽掃描及旋轉影像	11
5.2	Changing the Scan Settings During a Scan Job 掃描時改變掃描設定	13
5.3	Scan Auto 自動掃描	15
6	Extra Information 更多資訊	16
6.1	Setup And Use Scan To Email (設定及使用掃描至電郵)	16
6.2	Setup Scan to PC(SMB) 設定掃描至 PC(SMB)	16
6.3	Save An Address In The Address Book 儲存常用通訊至通訊簿	16

1 SCANNING PROCEDURE 掃描步驟

1.1 LOADING DOCUMENT 放置原稿

1.1.1 Document Feeder 自動送稿裝置

Remove any paper clips and staples before loading a document.

放置文件前，請取下萬字夾和清走打釘。

1. Load the document face up (when the document is 2- sided, place the front side up) in the center of the document feeder.

1. 將文件正面朝上 (若是雙面文件，將正面朝上) 放置在送稿裝置的中央。

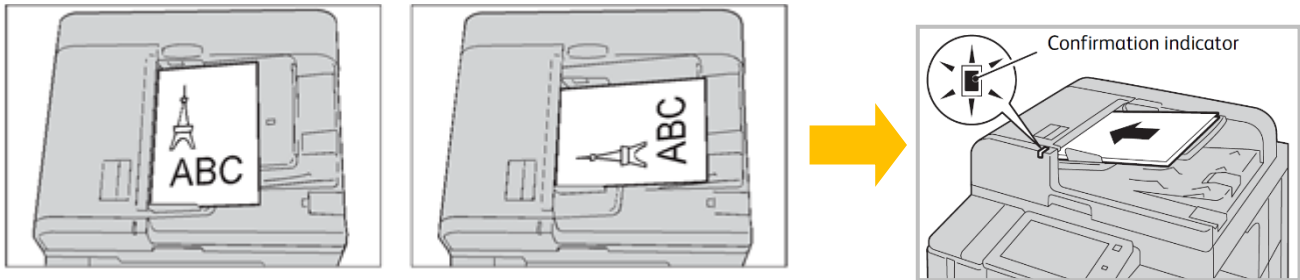

2. Adjust the document guides to match the size of the document loaded. Raise the document stopper.

2. 調整原稿調整桿至符合紙張尺寸，抬起擋紙器。

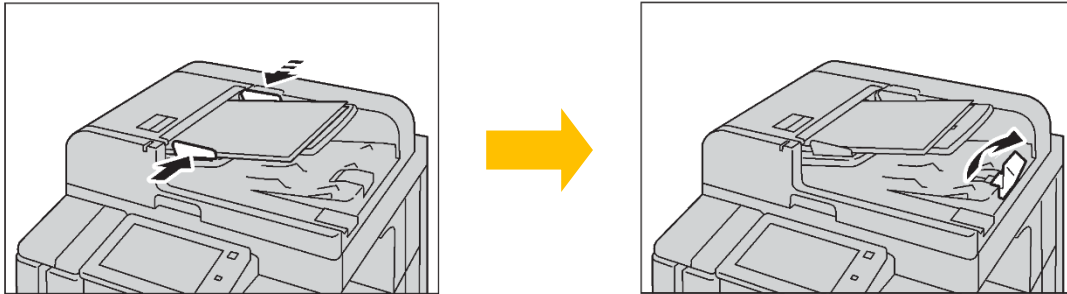

1.1.2 Document Glass 玻璃面板

1. Open the document cover.
2. Load the document face down, and align it against the top left corner of the document glass. Close the document cover.

1. 開啟原稿外蓋。
2. 將文件的正面朝下，對準玻璃面板的左上角放置並關閉原稿外蓋。

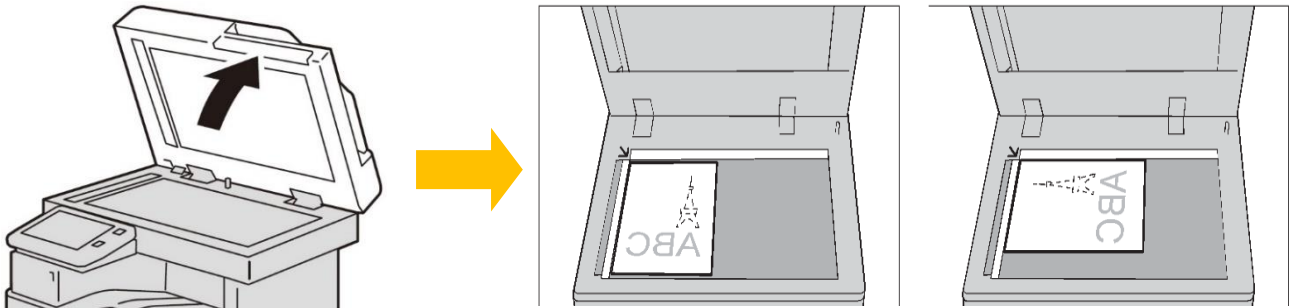

1.2 SELECTING SCAN LOCATION 選擇掃描貯存位置

1. Press the Home button.

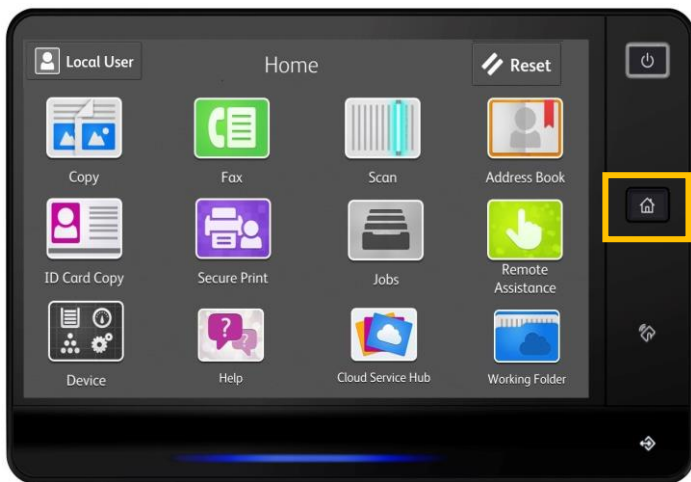

1. 按一下首頁按鈕。



2. Select a [Scan].

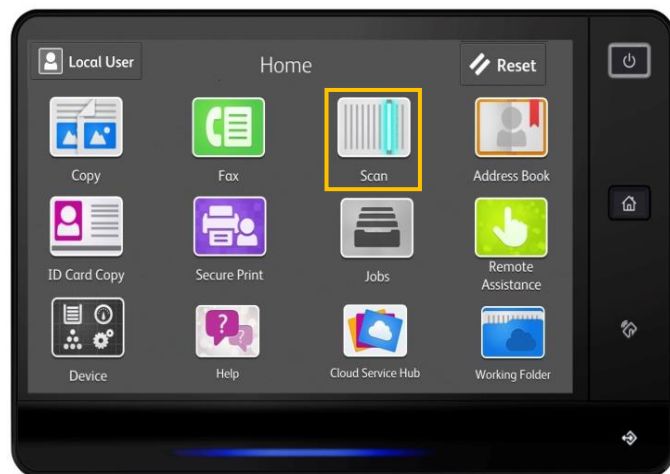

2. 選擇[掃描]。



3. Select [Contacts].

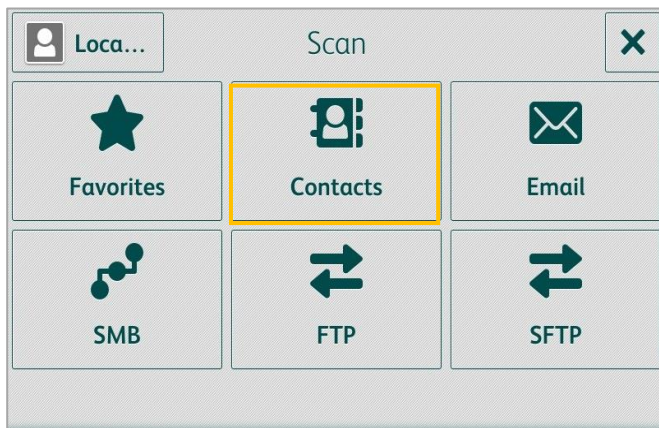

3. 選擇 [聯絡人]。



3. Select user's scan location and press [OK].

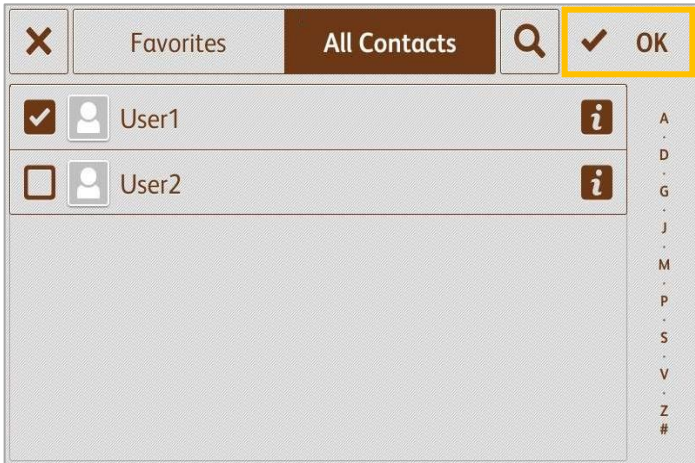

4. 選擇用戶的掃描位置，然後按[OK]。



5. Confirm selected scan location and press [Send / Scan].

4. 確定所選擇的掃描儲存位置，然後按[送信 / 掃描]。

Multi-location : PC & Email

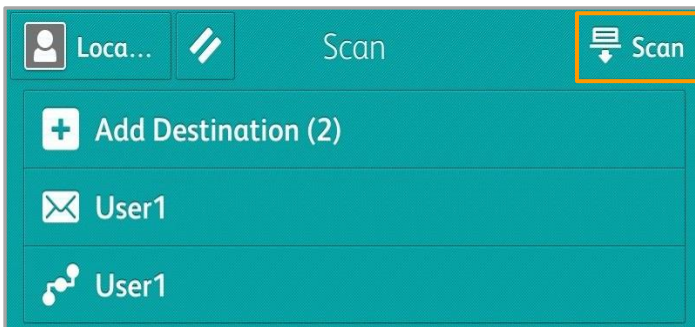

混合儲存位置 : PC & 郵件



Email scan

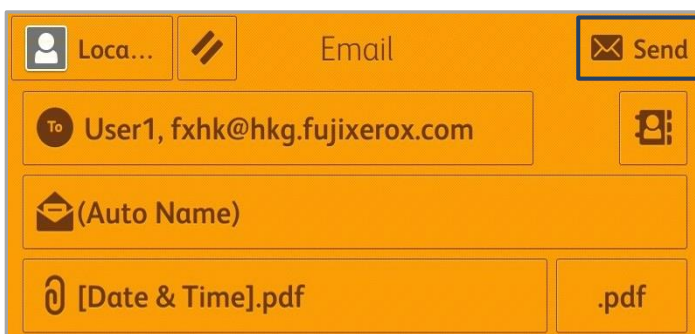

郵件送信



2 SCANNING FEATURES 掃描選項

2.1 SCANNING COLOR 色彩模式

Set the scanning color for the documents to be scanned.

Auto Detect:

The color of the document is determined automatically.

Color:

Select to scan a color document.

Black & White:

Scans a document in monochrome 2 tones.

Grayscale:

Scans a document in grayscale. It is suited to documents containing gradations that cannot be reproduced with monochrome.

設定掃描原稿時的色彩模式。

自動:

本機自動判定原稿的色彩。

全彩:

選擇掃描彩色原稿。

黑白 (2 色階):

以黑白雙色掃描原稿。

灰階 (256 色階):

以灰階掃描原稿。適合用於含有漸層且無法以黑白 (雙色) 方式重現的原稿。

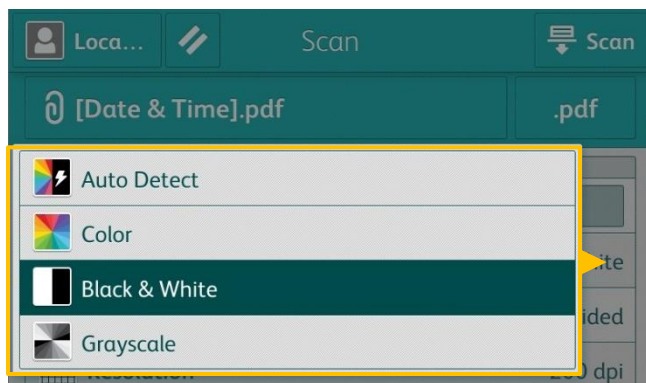

2.2 2-SIDED SCANNING 雙面原稿輸送

Select to scan both sides of a 2-sided document.

1 Sided:

Select this to scan only 1 side of the document.

2 Sided (Head to Head):

Select this when both sides of the 2-sided document are in the same orientation.

2 Sided (Head to Toe):

Select this when both sides of the 2-sided document are in the opposite orientation.

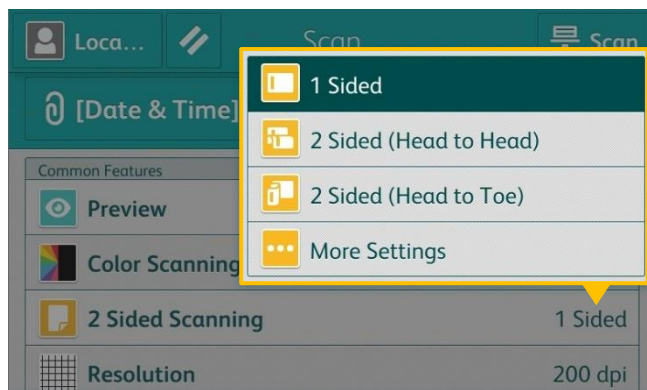

設定掃描雙面原稿的兩面。

單面:

只掃描原稿單面時，選擇此項目。

雙面 (左右對開):

雙面原稿的兩面都在同一方向時，選擇此項目。

雙面 (上下對開):

雙面原稿的兩面相反方向時，選擇此項目。



2.3 ORIGINAL TYPE 原稿類型

Photo & Text:

Select this item when the scanning document contains both text and photos.

Text:

Select this item when scanning text clearly.

Photo:

Select this item when scanning photos.

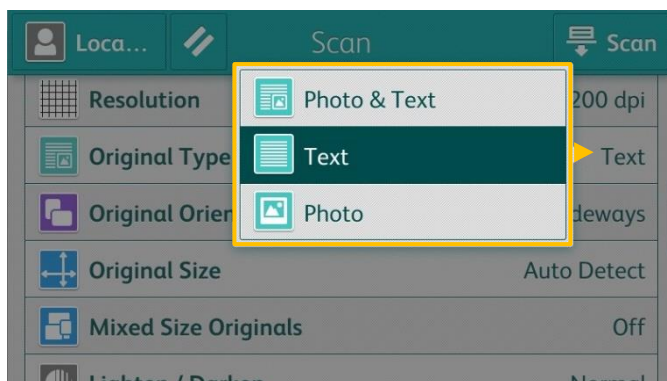

文字/ 照片:

掃描包含文字及照片的原稿時選擇此項目。

文字:

若要清晰掃描文字，請選擇此一項目。

照片:

掃描照片時，請選擇此選項。



2.4 FILE FORMAT 印出檔案格式

Select the format of scanned data.

TIFF/JPEG Auto Select:

Automatically selects JPEG or TIFF. [JPEG] for full color and grayscale images, [TIFF] for monochrome.

TIFF:

Saves multiple pages as 1 TIFF file.

JPEG:

Saves as a JPEG file.

PDF:

Saves as a PDF file.

DocuWorks:

Saves as a DocuWorks file.

More Settings...

Single File for Each Page:

Saves each page as a single file in the specified format.

選擇掃描資料的格式

TIFF/JPEG 自動:

自動選取 JPEG 或 TIFF。全彩與灰階影像為 [JPEG]，單色則為 [TIFF]。

TIFF:

以 1 個 TIFF 檔儲存多頁。

JPEG:

以 JPEG 檔儲存。

PDF:

以 PDF 檔儲存。

DocuWorks:

以 DocuWorks 檔儲存。

詳細設定

每頁皆進行分割:

使用指定格式將各頁分別儲存為一個檔案。

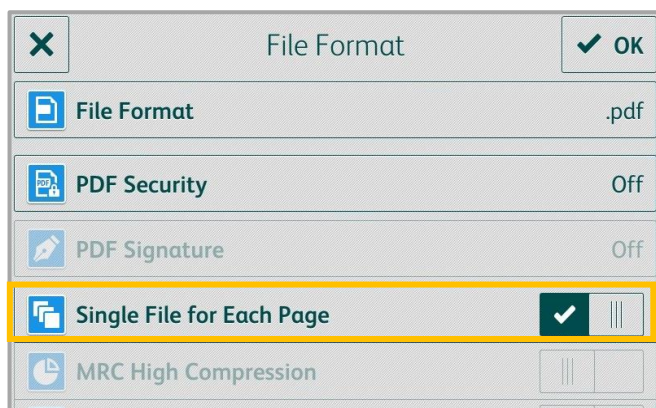
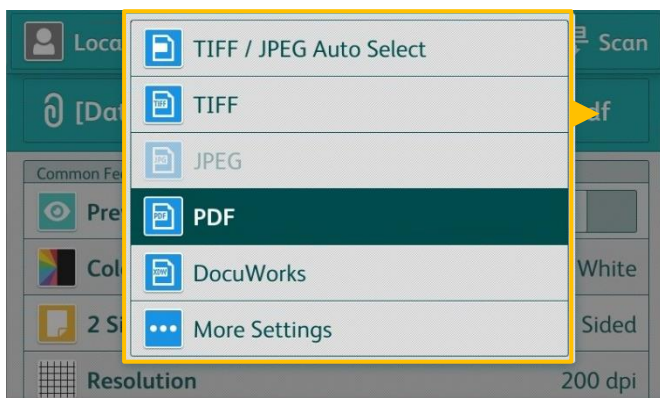

2.5 RESOLUTION 掃描解析度

Set the resolution for the documents to be scanned.

1. Select [Resolution].

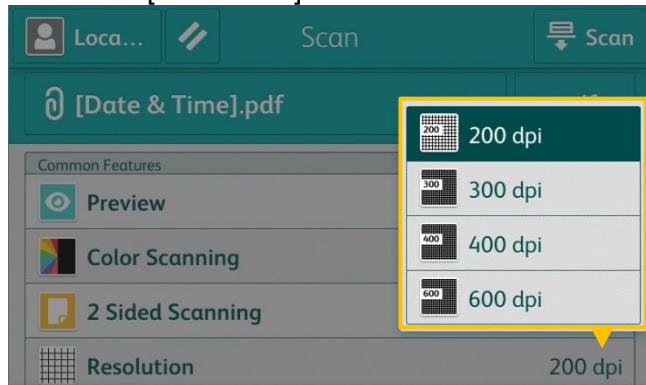

設定掃描原稿的解析度。

1. 選擇【掃描解析度】。



2.6 FILE NAME 檔案名稱

When using the [Email] or [Scan to PC] feature, you can specify the file name of the document to be sent.

1. Select the [File Name: Auto Name].

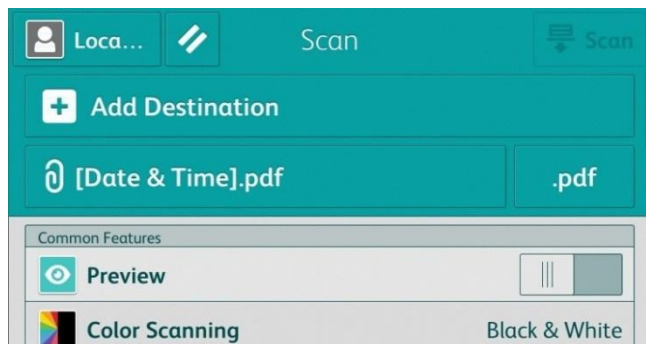

使用【掃描 (郵件送信)】或【掃描 (PC 儲存)】功能時，您可指定所發送檔案的名稱。

1. 選擇【檔案名稱: (自動設定)】。



2. Use the displayed keyboard to enter a name up to 28 characters. Press [Enter] when finished.



2. 使用顯示出來的鍵盤輸入最多 28 個字元的名稱，然後按【Enter】。

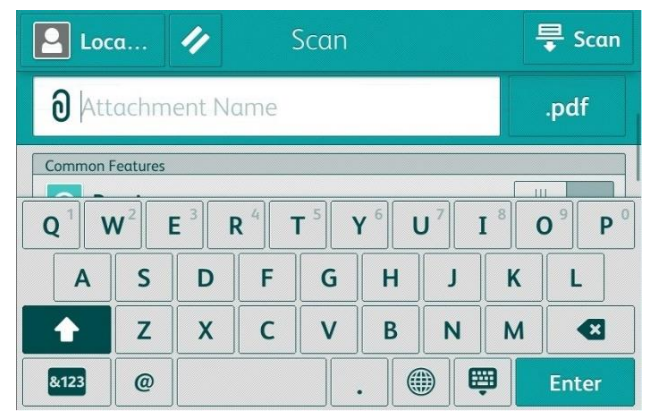

3 OPERATIONS DURING SCANNING 掃描期間的操作

3.1 STOP THE SCAN JOB 停止掃描

1. Press the [Pause] button on the touch screen.

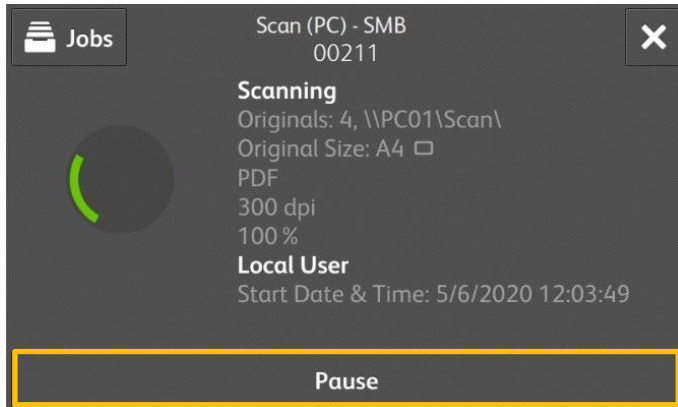

2. Press [Delete Job].

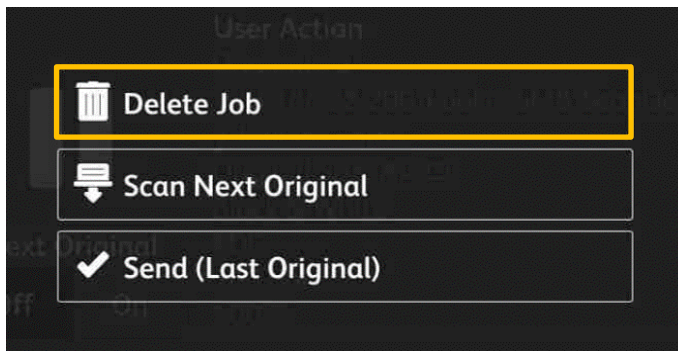

1. 按顯示幕上的【停止】。



2. 再按顯示幕上的【中止工作】。



4 LOAD THE NEXT DOCUMENT 放置下一份原稿

If you have another document to scan, turn [Next Original] on while the current document is being scanned.

1. Turn on [Next Original] while scanning is in progress.

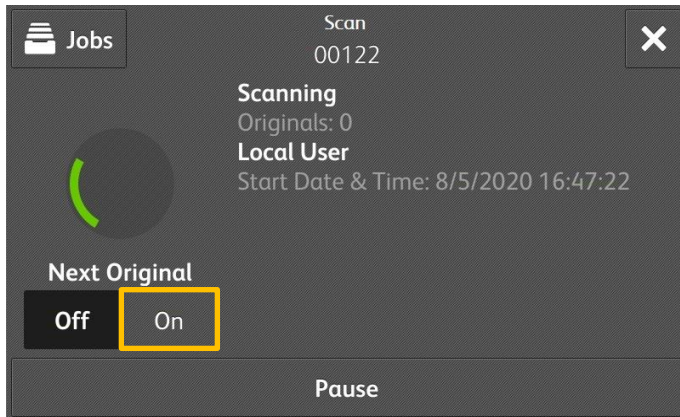

2. Load the next document.

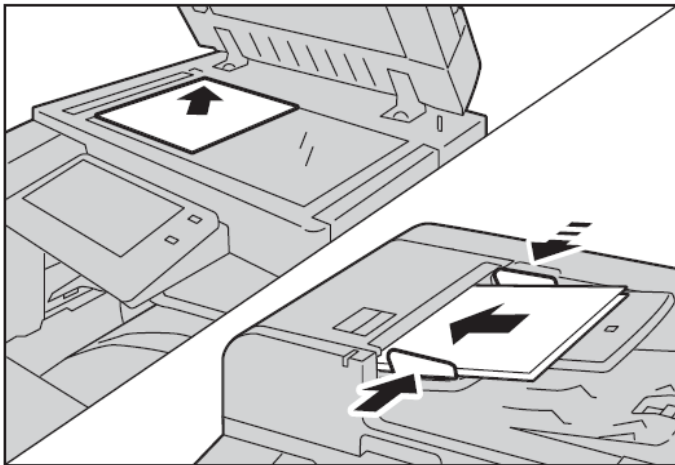

3. Press [Scan Next Original].

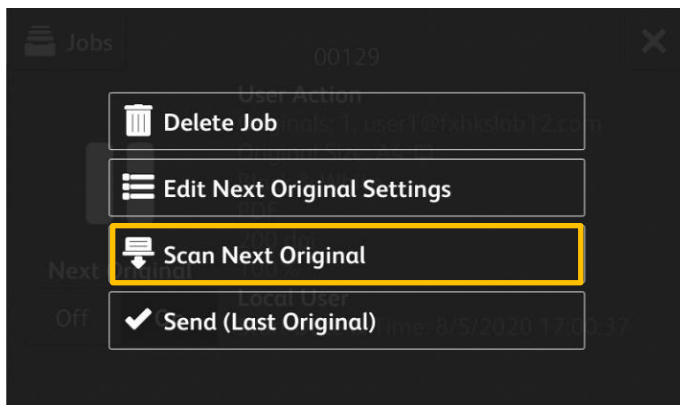

如果還有其他原稿需要掃描，請在掃描原稿時，在顯示幕上選擇【有下一張原稿】。

1. 請在【下一張原稿】掃描進行期間選擇【有】。



2. 放入下一份原稿。

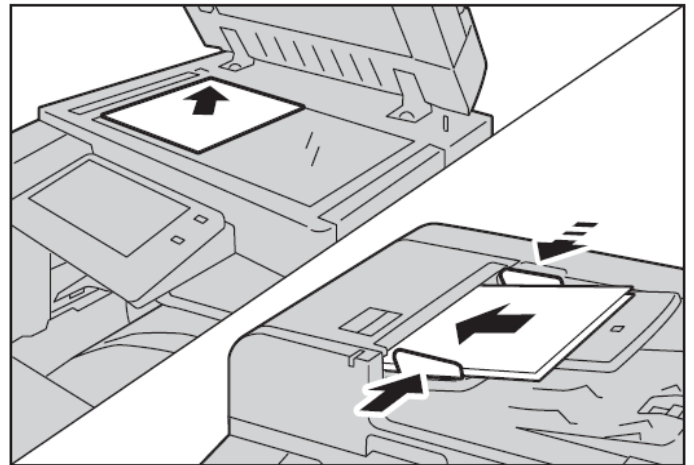

3. 按【掃描下一張原稿】。



4. When all documents scanned, select [Send (Last Original)].

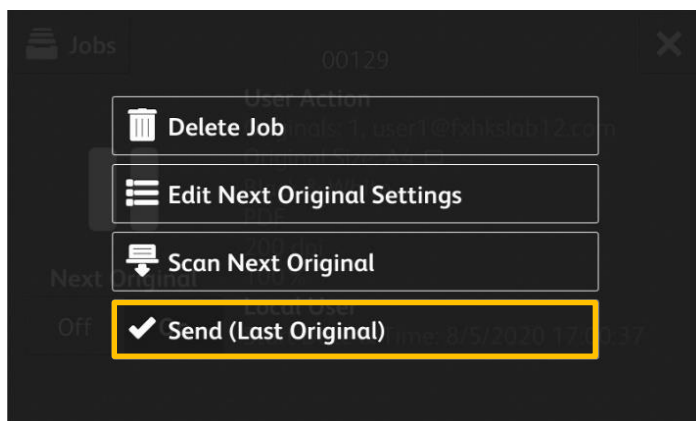

4. 所有原稿掃描之後，請選擇【送信(無下一張)】。



5 SPECIAL FEATURES 特別功能

5.1 PREVIEWING AND ROTATING THE SCANNED IMAGES 預覽掃描及旋轉影像

You can preview and rotate the scanned images while scanning the document.

掃描文件時，您可以預覽及旋轉掃描影像。

1. Select [Preview] and press  Preview to start scan.

1. 選擇【預覽】並按  預覽 以開始掃描。

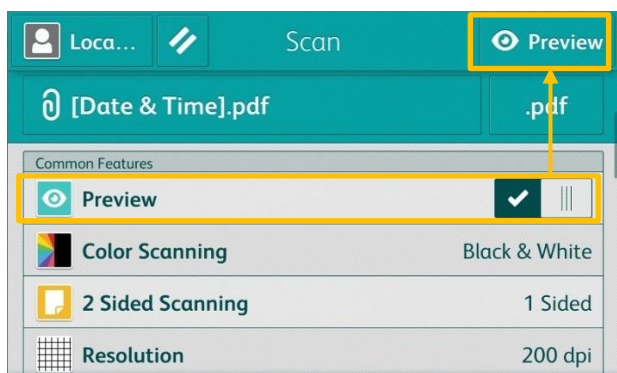

2. After the document scanned, the entire scanned image will be displayed.

2. 文件掃描之後，就會顯示整份掃描文件的預覽影像。

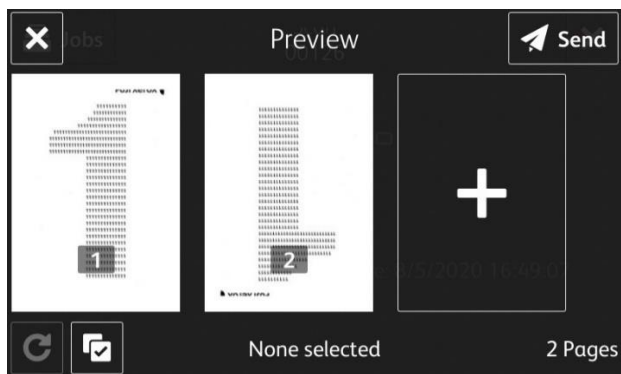

3. Select the pages and press  to rotate the scanned image in correct direction.

3. 選擇所需的文件頁面，然後按  將文件頁面旋轉至正確的方向。

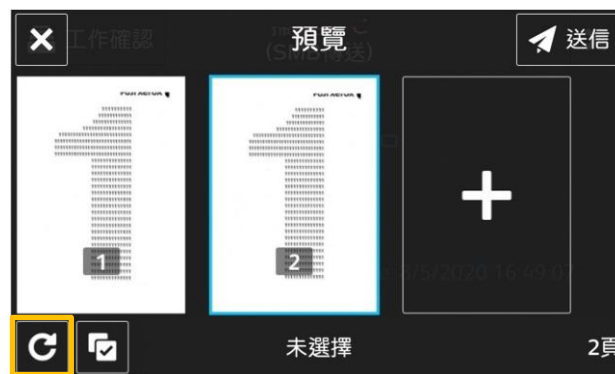
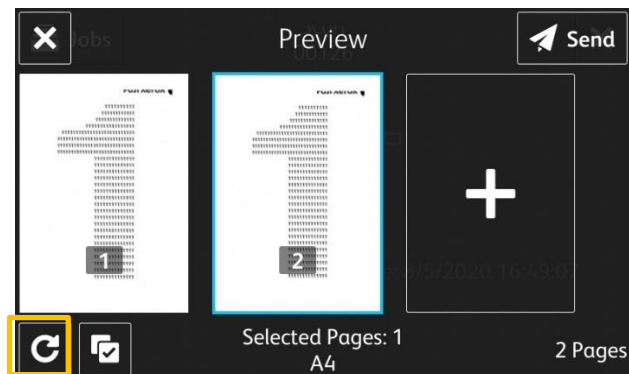

4. When you have finished preview and rotate the document, select [Send].

4. 當完成預覽及旋轉文件後，選擇【送信】。

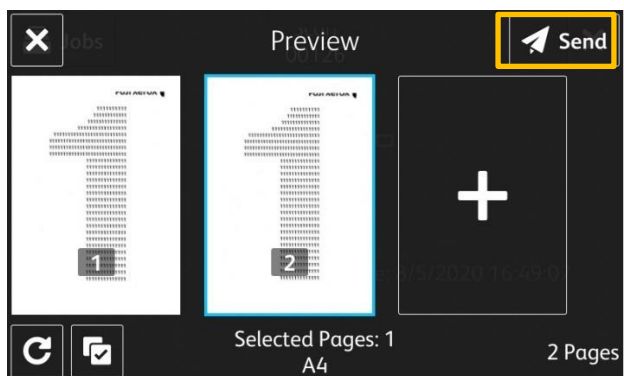

5.2 CHANGING THE SCAN SETTINGS DURING A SCAN JOB 掃描時改變掃描設定

1. Select [Preview] and press  .

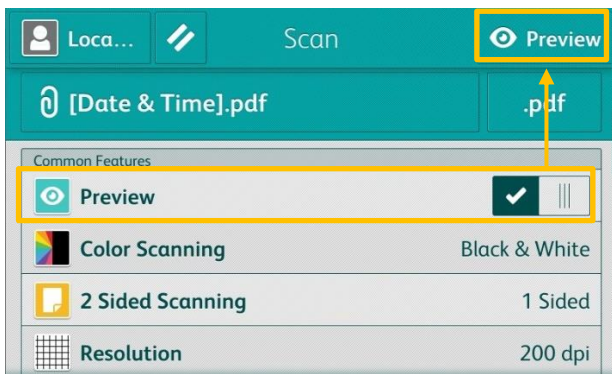

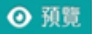
1. 選擇【預覽】，然後按  。



2. After the document scanned, select  .

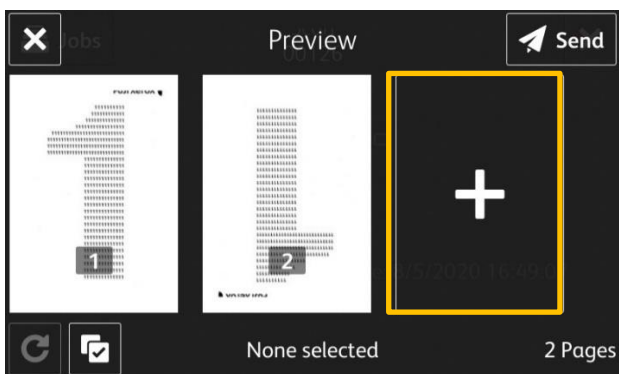

2. 文件掃描之後，選擇  。



3. Press [Change Settings].

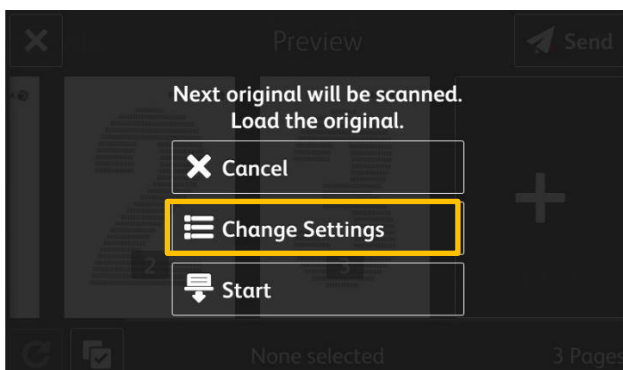

3. 按【掃描設定】。



4. Change the scan settings, then press [Scan].

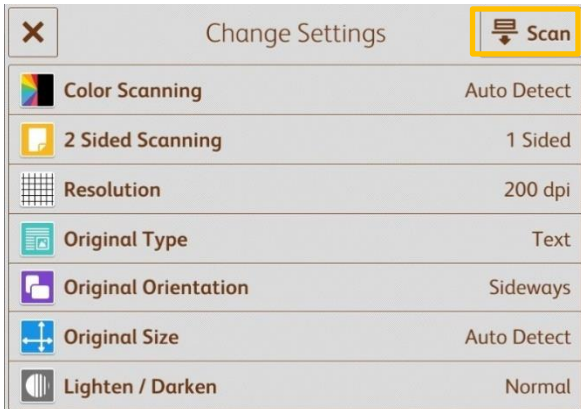

4. 變更掃描設定，按【掃描】。



5. Ensure and preview all scanned documents, then press [Send] to complete.

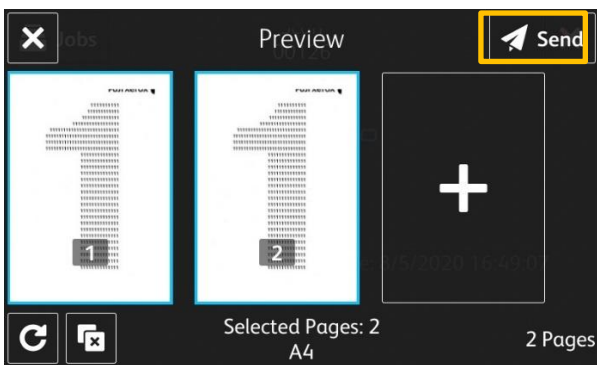

5. 確定並檢視所有掃描文件的預覽影像，然後按【送信】完成掃描。



5.3 SCAN AUTO 自動掃描

Scan Auto can skip the blank pages and rotate the pages into correct orientation automatically.

自動掃描能自動地把白頁去除及把頁面自動正立。

1. Select [Scan Auto].

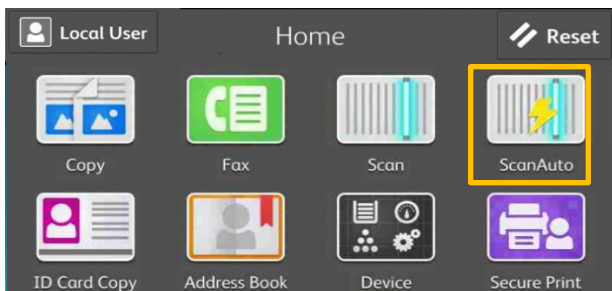

1. 選擇【自動掃描】。



2. Specify recipient(s) using 

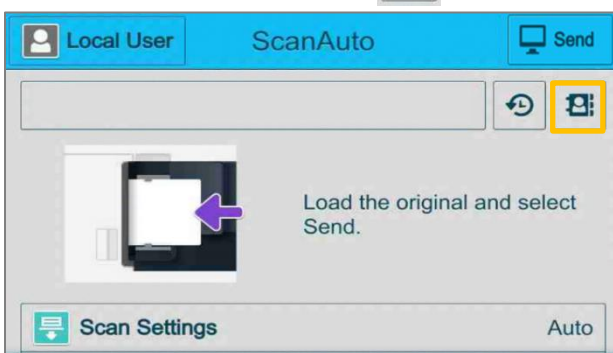

2. 選擇  並從地址清單選擇收件人地址。



3. Choose the recipient(s).



3. 選擇通訊對象。



4. Press [Send].

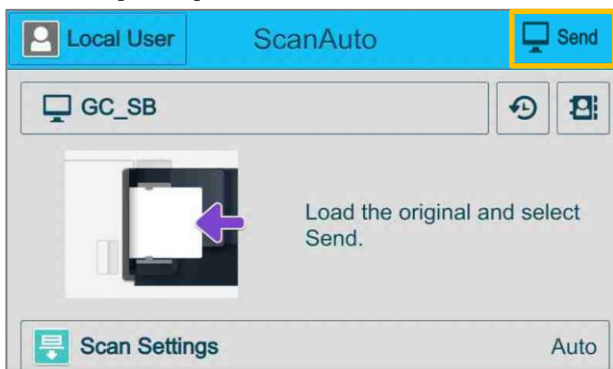

4. 選擇通訊對象並按【送信】。



6 EXTRA INFORMATION 更多資訊

6.1 SETUP AND USE SCAN TO EMAIL (設定及使用掃描至電郵)



Setup and use scan to email

設定及使用掃描至電郵

Scan QR Code OR Click [here](#)

請掃描 QR Code 或者點擊[這裡](#)

6.2 SETUP SCAN TO PC(SMB) 設定掃描至 PC(SMB)



Setup scan to PC(SMB)

設定掃描至 PC(SMB)

Scan QR Code OR Click [here](#)

請掃描 QR Code 或者點擊[這裡](#)

6.3 SAVE AN ADDRESS IN THE ADDRESS BOOK 儲存常用通訊至通訊簿



Save an address in the address book

儲存常用通訊至通訊簿

Scan QR Code OR Click [here](#)

請掃描 QR Code 或者點擊[這裡](#)

Customer Support Center

2513-2513

This document includes Fuji Xerox product(s), licensed from Xerox Corporation. The distributor of the product(s) is FUJIFILM Business Innovation Corp.
Xerox, Xerox and Design, as well as Fuji Xerox and Design are registered trademarks or trademarks of Xerox Corporation in Japan and/or other countries.
FUJIFILM and FUJIFILM logo are registered trademarks or trademarks of FUJIFILM Corporation.
ApeosPort and DocuWorks are registered trademarks or trademarks of FUJIFILM Business Innovation Corp.