

Quick Reference Notes – **DAILY CARE**

簡易操作 - **日常保養**

ApeosPort[®]V C7785/C6685/C5585

CONTENTS

目錄

1	Clear Paper Jam 夾紙排解.....	1
2	Replacing Toner & Waste Toner Container 更換碳粉匣及碳粉回收盒.....	4

1 CLEAR PAPER JAM 夾紙排解

i. Document Feeder / 送稿器

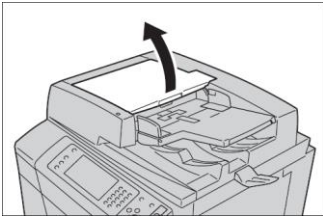

1

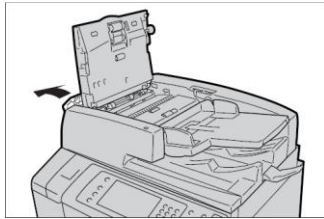

2

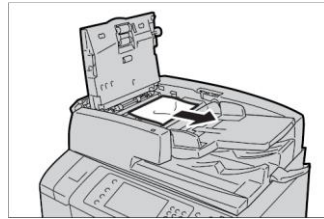

3

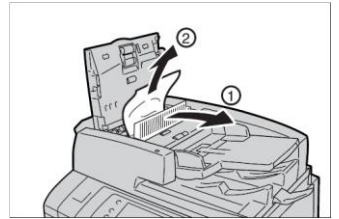

4

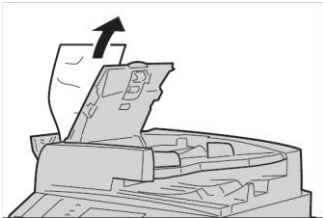

5

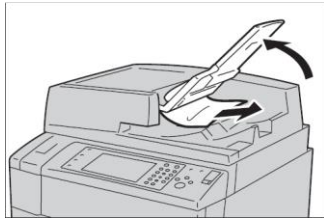

6

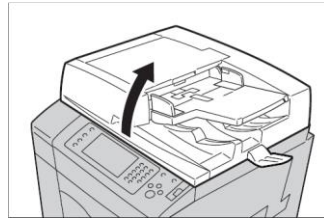

7

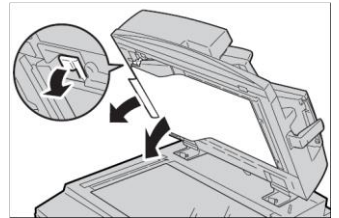

8

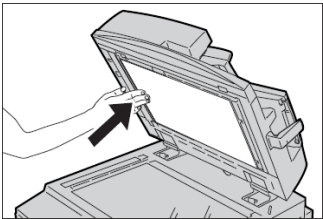

9

ii. Tray 5 (Bypass) / 紙盤 5 (手送紙盤)

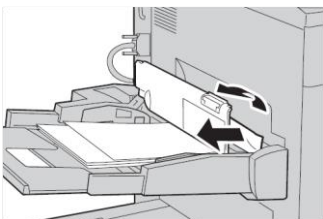

1

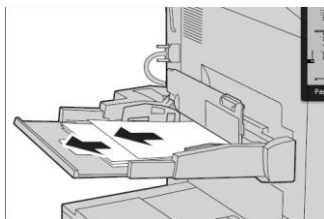

2

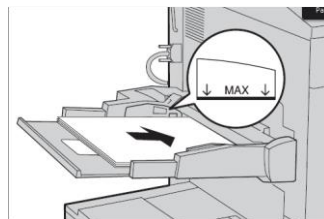

3

iii. Paper Jams in the Transfer Module / 轉印裝置

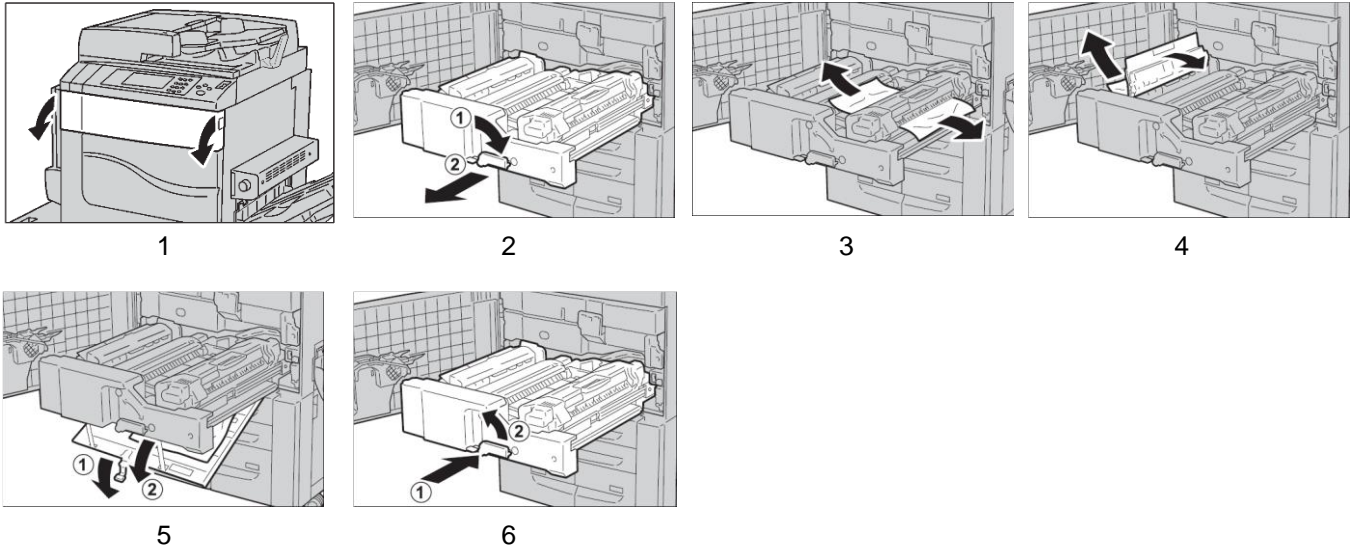

iv. Bottom Left Cover C / 左下蓋 C

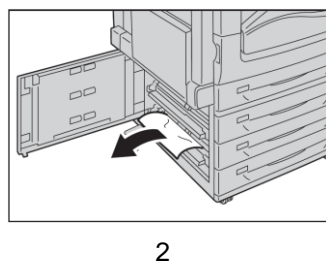
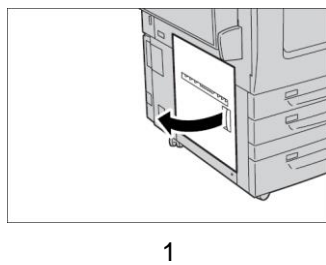

v. Bottom Right Cover / 右下蓋

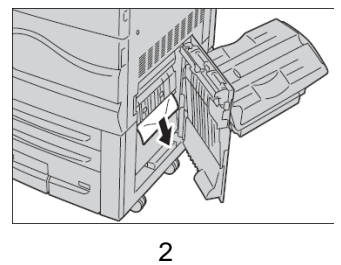
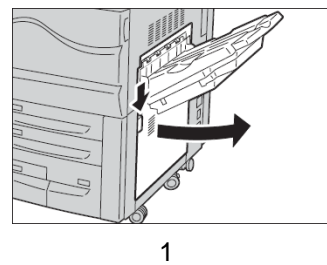

vi. C Finisher / 用 C 型裝訂檢集機

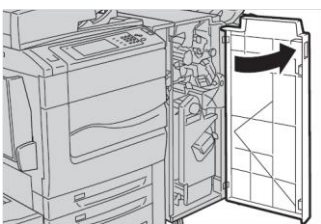

Open the Cover

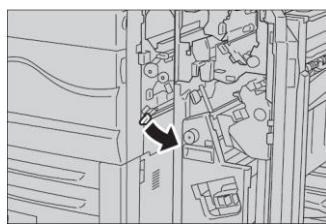

Paper Jam at the Lever 1a & 1b

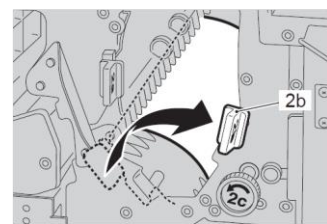

Paper Jam at the Lever 2a, 2b, 2c & 2d,

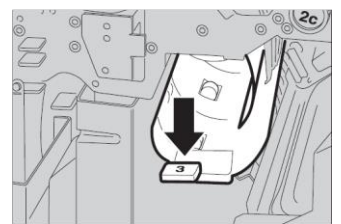

Paper Jam at the Lever 3

vii. D Finisher / 用 D 型裝訂檢集機

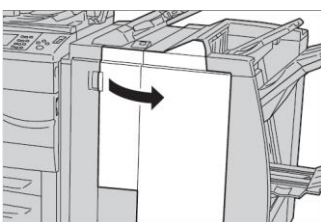

Open the Cover

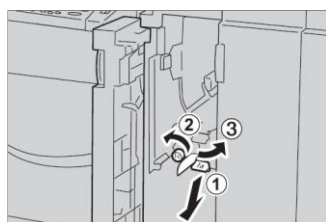

Paper Jam at the Lever 1a, 1b, 1c & 1d



Paper Jam at the Lever 2a,



Paper Jam at the Lever 3a, 3b, 3c, 3d, 3e, 3f & 3g

viii. Paper Jam at the 4a(for the Finisher C & D w/ Booklet) / C & D 型裝訂檢集機 4 a 位置

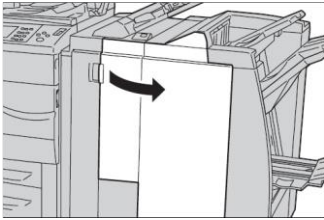

1

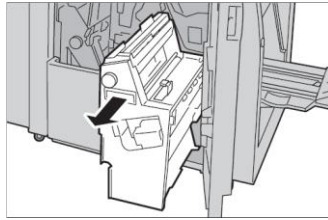

2

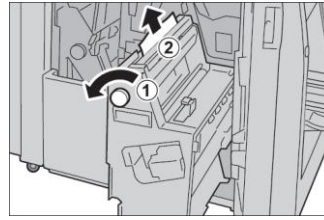

3

ix. Paper Jam at the Booklet Output Tray (For the Finisher C & D w/Booklet) / C & D 型裝訂檢集機出紙處

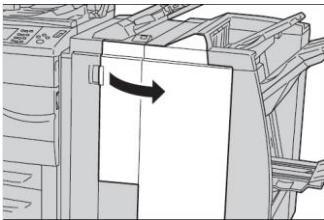

1

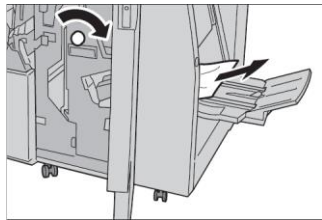

2

2 REPLACING TONER & WASTE TONER CONTAINER

更換碳粉匣及碳粉回收盒

i. Replacing Toner / 更換碳粉匣

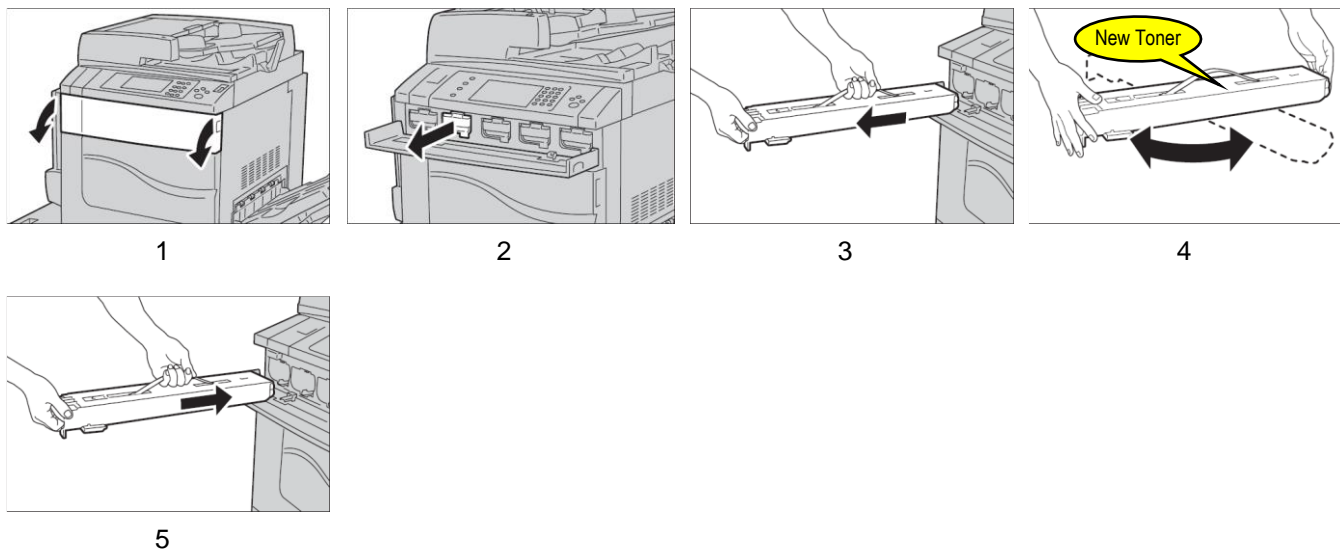

ii. Replacing Waste Toner Container / 更換碳粉回收匣

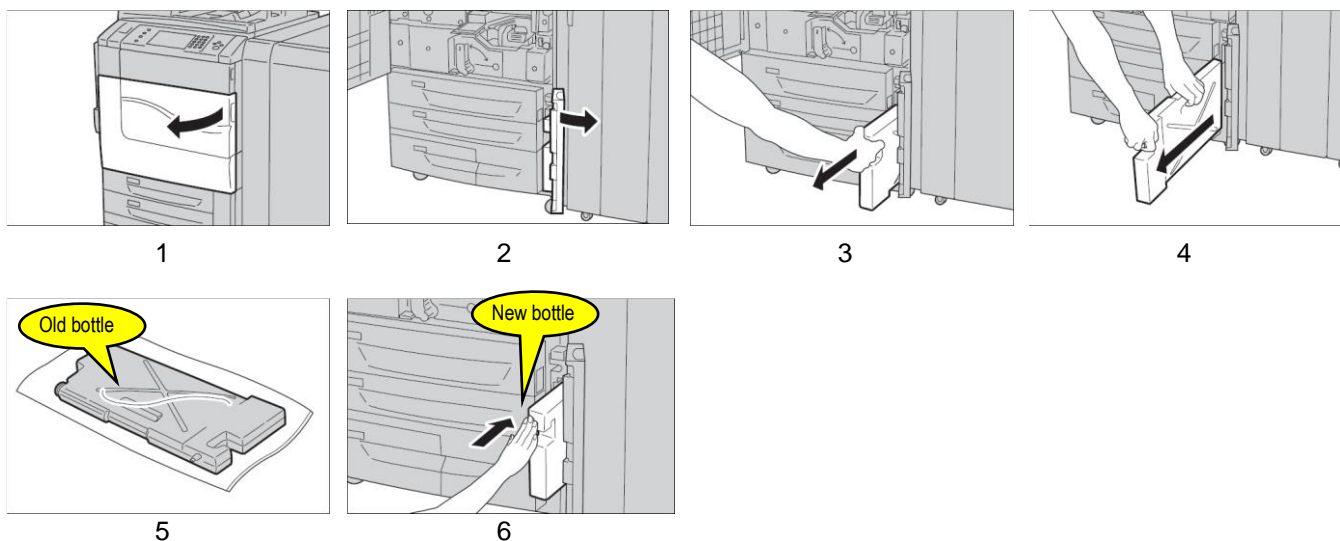

Scan QR Code OR Click [here](#) for video version of this chapter.

請掃描 QR Code 或者點擊 [這裡](#) 查看本章的視頻版本

For more online support information please visit

更多相關資料，請訪問以下網址：

<https://support-fb.fujifilm.com>

Customer Support Center

2513-2513

This document includes Fuji Xerox product(s), licensed from Xerox Corporation. The distributor of the product(s) is FUJIFILM Business Innovation Corp.
Xerox, Xerox and Design, as well as Fuji Xerox and Design are registered trademarks or trademarks of Xerox Corporation in Japan and/or other countries.
FUJIFILM and FUJIFILM logo are registered trademarks or trademarks of FUJIFILM Corporation.
ApeosPort and DocuWorks are registered trademarks or trademarks of FUJIFILM Business Innovation Corp.