

Quick User Guide

Apeos C8180/7580/6580













# Features Content

Thank you for selecting the FUJIFILM Business Innovation Apeos C8180/7580/6580 (hereafter referred as “the machine”, the “device” or “the printer”).

This complimentary user guide describes the fundamental operations on Copy, Print, Scan, and Fax procedures of the machine for ease of use of the machine.

## Quick User Guide Organization

 <b>Overview</b> .....	03	 <b>Fax</b> .....	<b>25-26</b>
 <b>Copy</b> .....	<b>04-12</b>	Single / Multiple Recipients .....	25
Reduce / Enlarge .....	04	2-Sided Faxing .....	25
2-Sided Copying .....	05	Confirmation Report .....	26
Book Copying .....	06	 <b>USB Media</b> .....	<b>27-29</b>
Copy Output .....	07	Media Print Text / Photos .....	27
Mixed Size Originals .....	08	Store to USB .....	28
Pages per Side .....	09	Mobile Printing .....	29
Booklet Creation .....	10	 <b>Troubleshooting</b> .....	<b>30-33</b>
Edge Erase.....	11	Clearing Paper Jams.....	30
ID Card Copying.....	12	Replacing Consumables .....	33
 <b>Print</b> .....	<b>13-19</b>	 <b>Machine/Job Status</b> .....	<b>34-36</b>
Job Type / 2-Sided Print .....	13	Billing/Supplies Information .....	34
Release Secure Print .....	14	Consumables Part No. ....	35
Booklet Creation .....	15	Job Status Screen .....	36
Pages per Sheet .....	16	 <b>Register New Address</b> .....	<b>37</b>
Watermark .....	17	Add New Address Book Entry .....	37
Direct Fax .....	18	 <b>Support &amp; Downloads</b> .....	<b>38</b>
Envelope.....	19	Drivers & User Guides .....	38
 <b>Scan</b> .....	<b>20-24</b>	 <b>EP-BB Self Registration</b> ....	<b>39-40</b>
Email .....	20	Online Registration .....	39
Scan to PC .....	21		
Scan to Folder .....	22		
Send from folder .....	23		
Advance Scan Features .....	24		

### IMPORTANT!

This Quick User Guide may not be copied or modified without the written consent of the author or publisher. Parts of this user guide are subject to change without prior notice. We welcome any comments on ambiguities, errors, omissions or missing pages.

The screen images in this guide solely used for illustration and are based on the standard machine configurations. Some features mentioned may not be used depending on the machine configurations. Unsupported features will not be displayed on the screen. Abnormal features will be grayed out on the screen.

Contact FUJIFILM Customer Training Department Malaysia for more information.

# Overview

## Control Panel / Touch Screen Overview

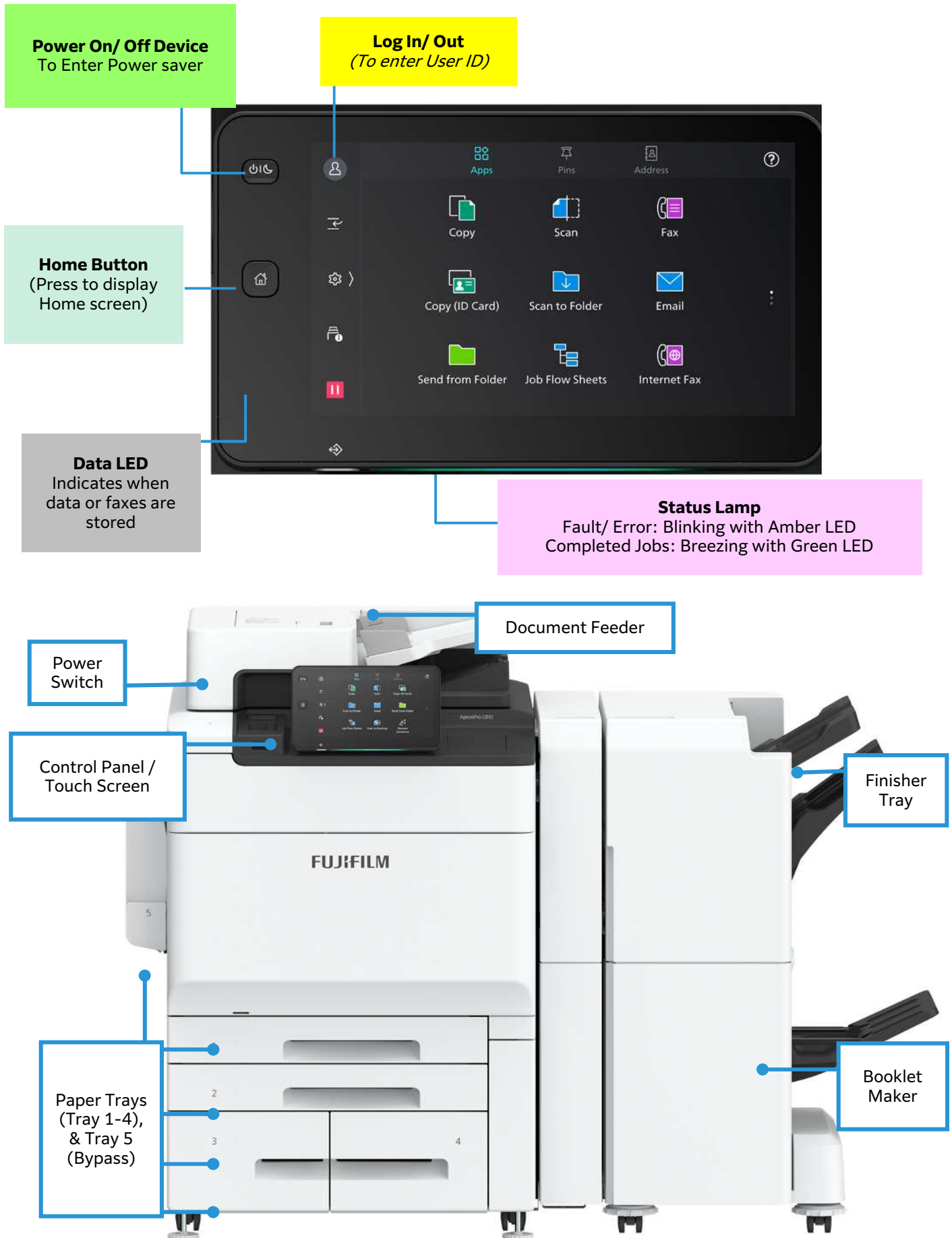

# Copy: Reduce or Enlarge...

•Allows you to select copy ratio to enlarge or reduce the size of copies



1. Load documents onto the Document Feeder / Platen Glass.

2. Tap on **[Copy]** on the Services Home screen.

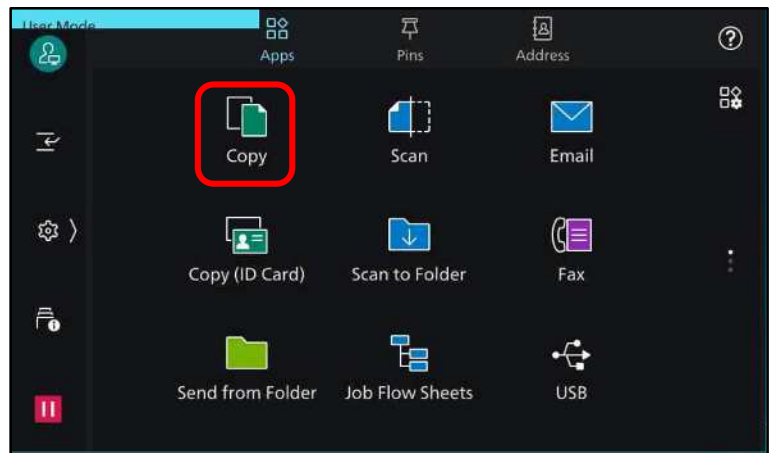

3. On the features list, tap on:  
a: **[Reduce/Enlarge]...**

for A3 to A4 : 70%

for A4 to A3 : 141%

b: **[Paper Supply]...**

Tray 1-4, Tray 5 (bypass)

4. Tap **[Quantity]** and enter number of copies.

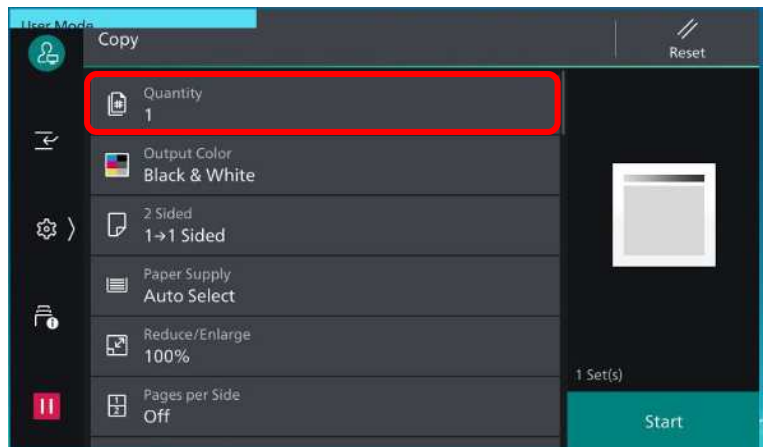

5. Tap on **[Start]** to copy.

Note: Tap  to restore all settings to their default

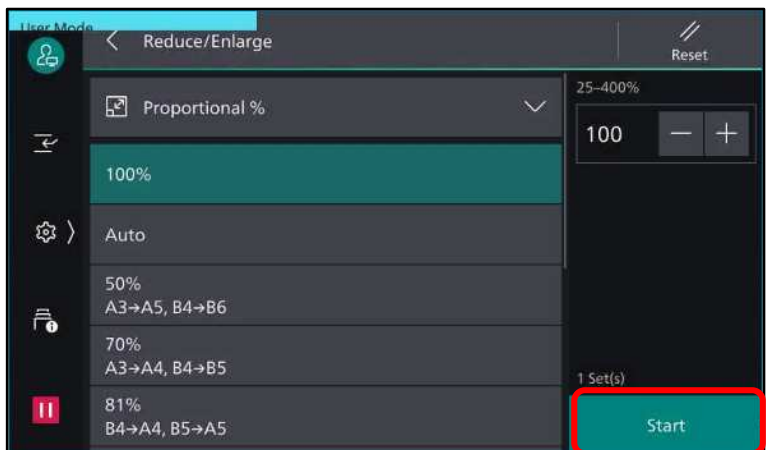

# Copy: 2-Sided Copying...

Make copies of 1-sided or 2-sided documents on one side or both sides of paper



1. Load documents onto the Document Feeder

2. Tap on **[Copy]** on the Services Home screen.

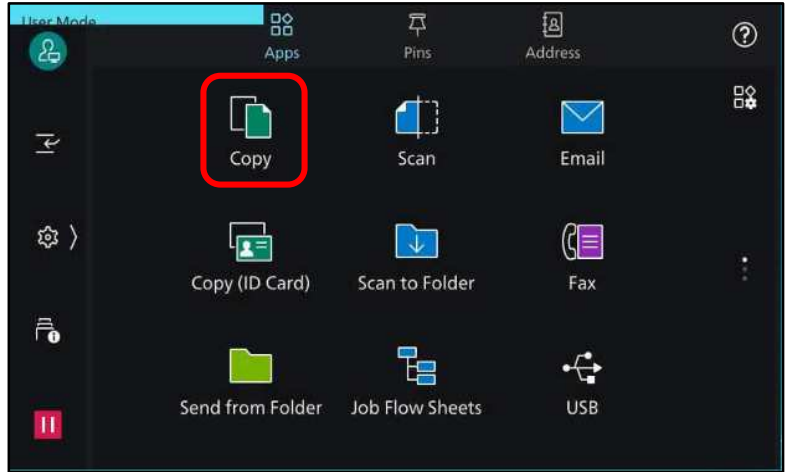

3. On the feature list, tap **[2 sided]**

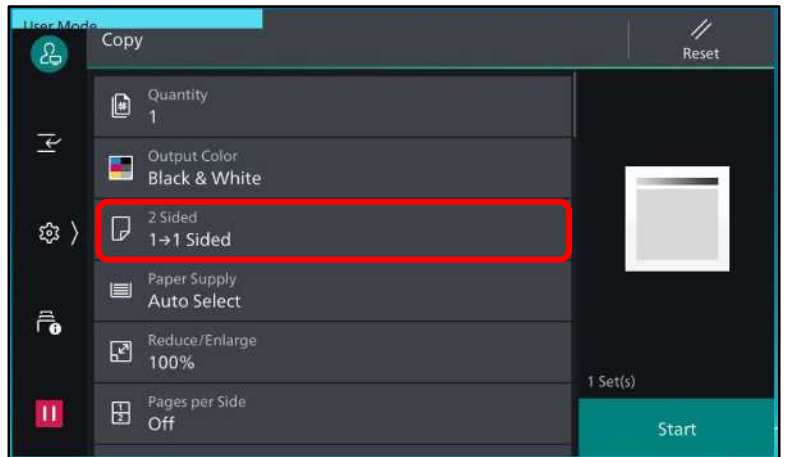

Choose between the option of:

- 1→1 Sided : copy a 1-sided document on one side of paper
- 1→2 Sided : copy a 1-sided document on both sides of paper
- 2→2 Sided : copy a 2-sided document on both sides of paper
- 2→1 Sided : copy a 2-sided document on one side of paper

4. Tap **[Start]** to copy.

Note: Tap on  or [Pause]

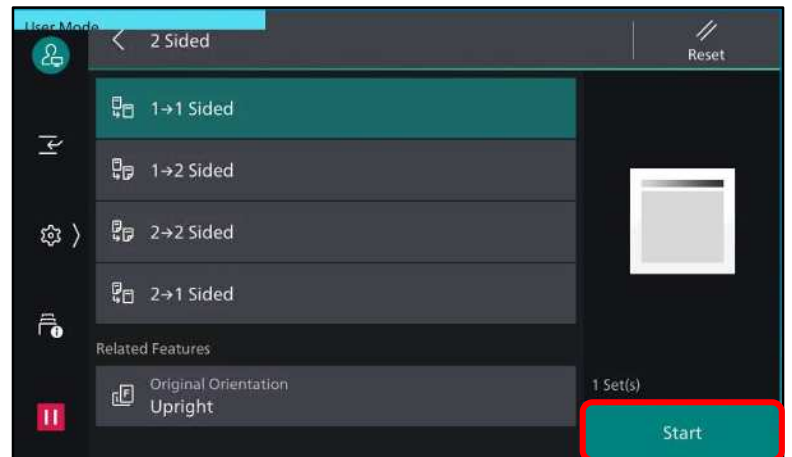

# Copy: Book Copying & 2-Sided Book Copying...

Allows you to copy bound documents such as books into separate sheets of paper

1. Place a book on the Platen Glass face down.
2. Tap **[Copy]** on the Services Home screen.

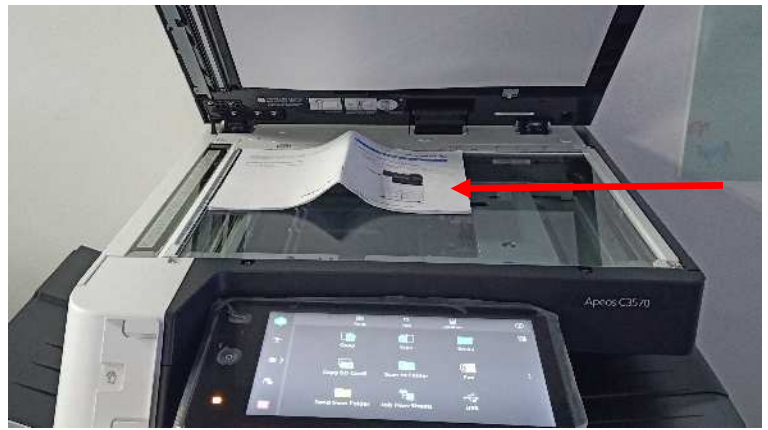

3. On the features list, scroll down until:
  - a. **[Book Copying]**  
copies 2 single- sided output
  - b. **[2-Sided Book Copying]**  
copies 2-sided output in the same order of the book

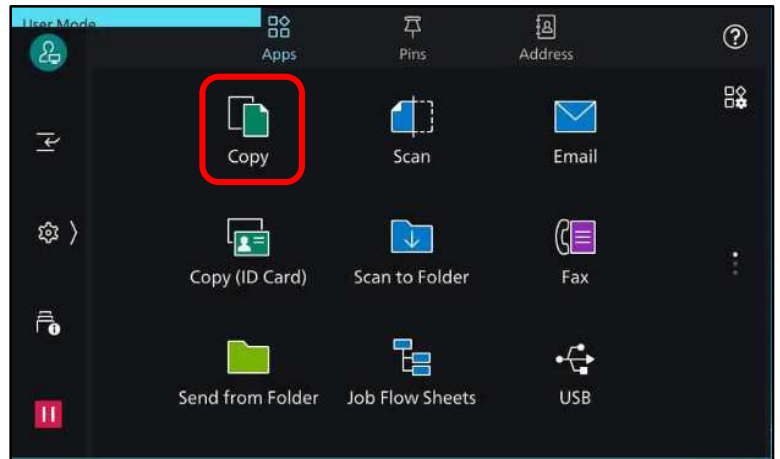

Tap any option:

- a. Left Page then Right
  - b. Right Page then Left
  - c. Top Page then Bottom
- Both Pages  
Left Page Only  
Right Page Only

4. Tap **[Start]** to copy.

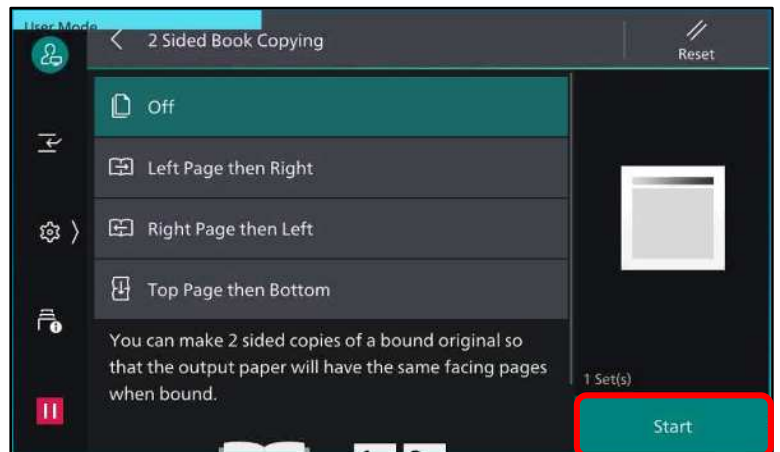
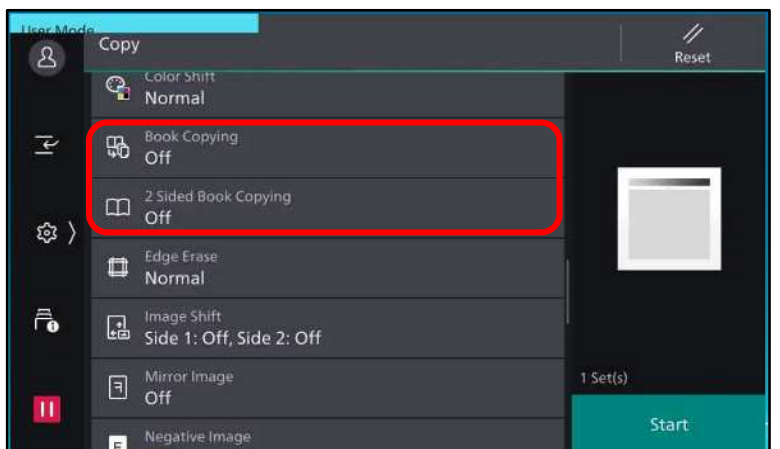

# Copy: Collated / Uncollated

**Collated:** sorted in sets and arranged in page order (optional: staple/hole punch)

**Uncollated:** printed in group according to specified quantity.



1. Load documents onto the Document Feeder or Platen Glass.

2. Tap **[Copy]** on the Services Home screen.

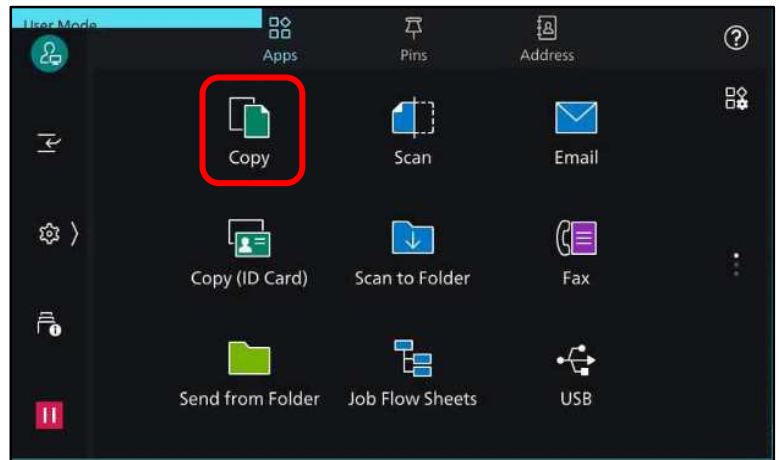

3. On the features list, scroll down until **[Copy Output]**

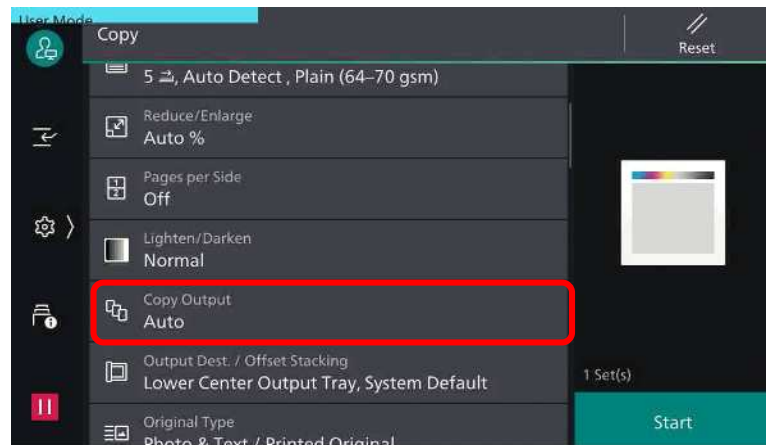

4. Choose the option:  
Auto  
Collated  
Uncollated  
Uncollated with Separators  
Optional: Staple / Hole Punch

Tap **[Start]** to copy.

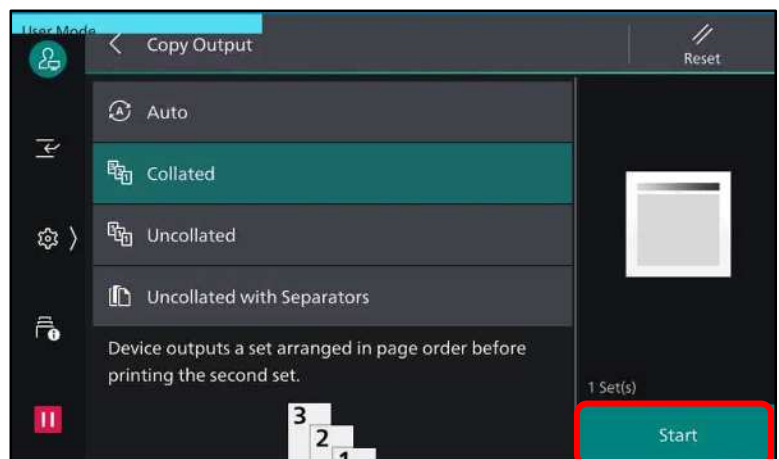

# Copy: Mixed Size Originals...

Allows different size documents copied onto matching output paper size.



1. Load documents onto the Document Feeder
2. Tap **[Copy]** on the Services Home screen.

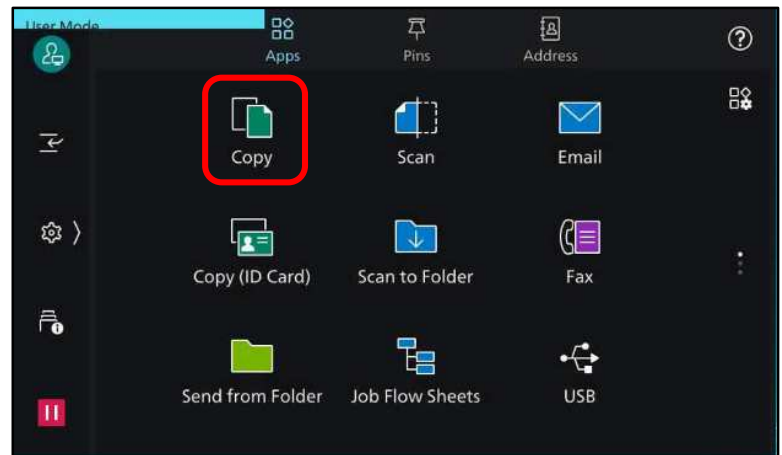

3. On the features list, scroll down until **[Mixed Size Originals]**.

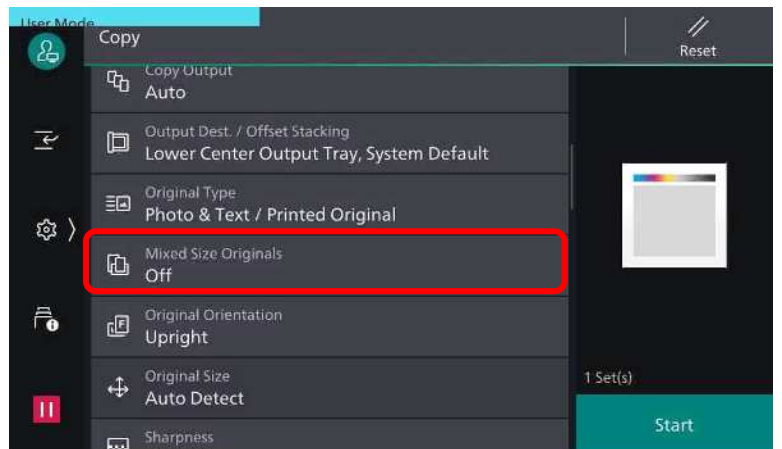

4. Tap **[Mixed Size Originals]** and select :  
OFF  
ON

5. Tap on **[Start]** to copy.

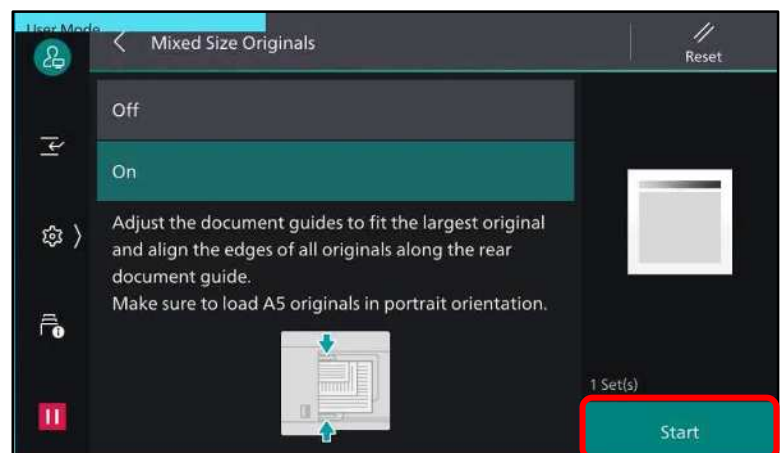



# Copy: Pages per Side (N-Up)...

Allows you to copy 2, 4, or 8 pages of documents on to a single sheet of paper.



1. Load documents onto the Document Feeder

2. Tap **[Copy]** on the Services Home screen.

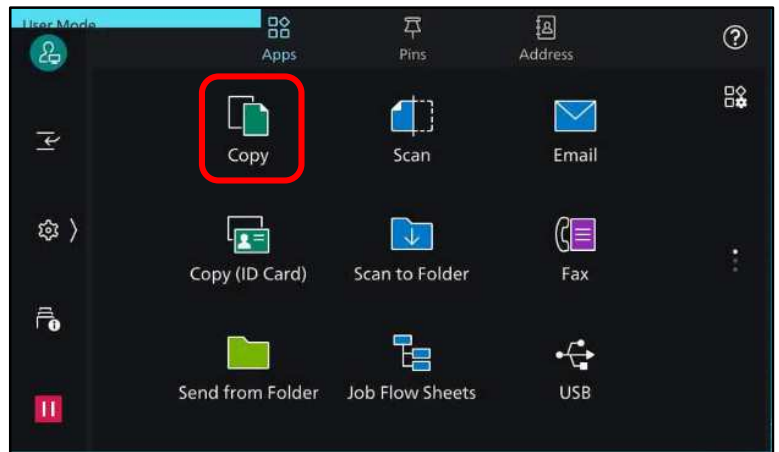

3. On the features list, scroll down to **[Pages per Side]**

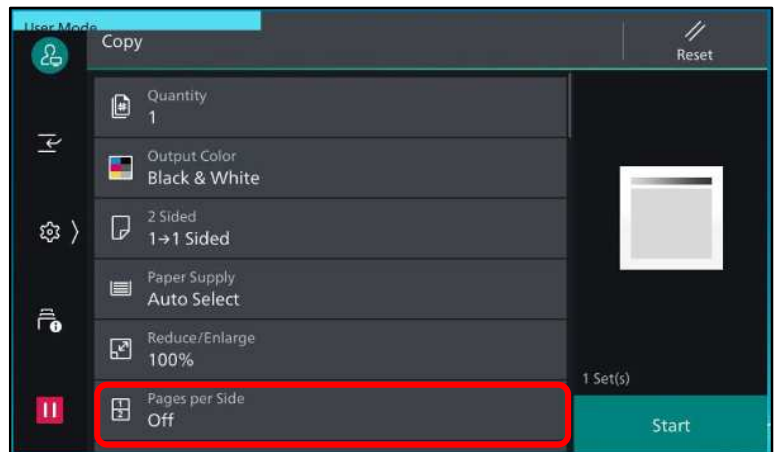

4. Tap the options:

- Off – feature not applied
- 2 Pages Up – 2 documents copied into 1 sheet of paper
- 4 Pages Up – 4 documents copied into 1 sheet of paper
- 8 Pages Up – 8 documents copied into 1 sheet of paper

Tap **[Start]** to copy.

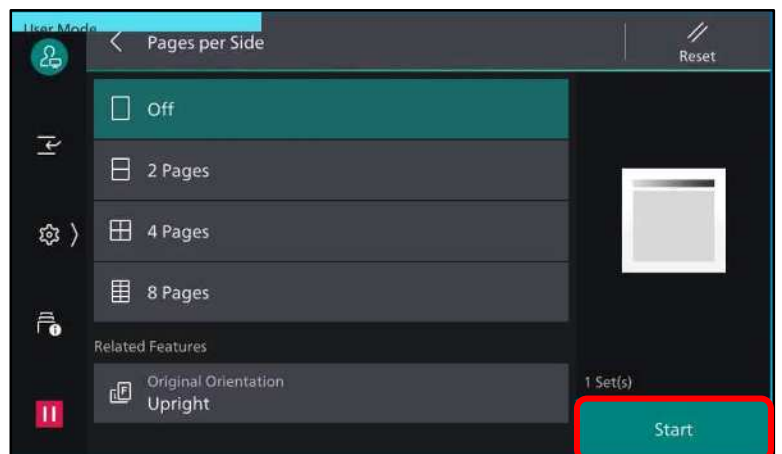

# Copy: Booklet Creation...

This feature copies the documents and form the output sheets into a booklet layout.  
\*optional fold & staple



1. Load documents onto the Document Feeder

2. Tap **[Copy]** on the Services Home screen.

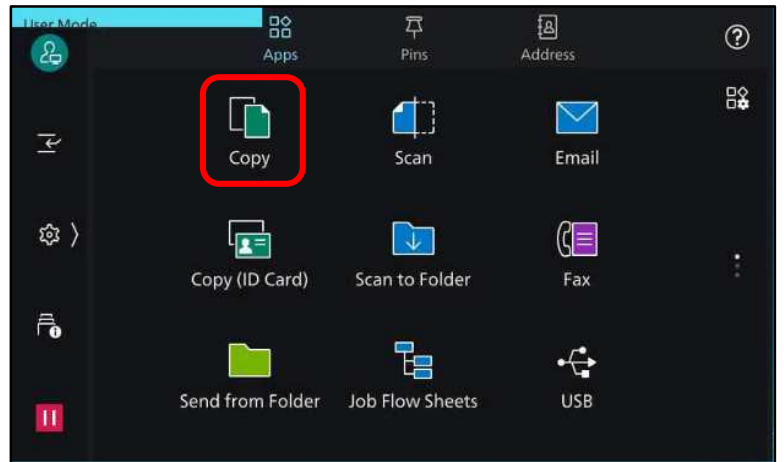

3. On the features list, scroll down to **[Paper Supply]** and choose any paper tray with landscape orientation paper.  
(e.g. Tray 3)

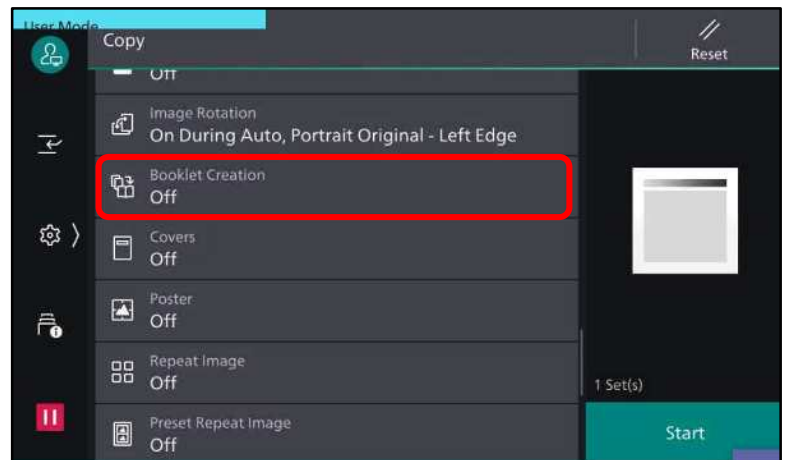

4. On the features list, scroll down to **[Booklet Creation]**, and choose the option:  
Off – feature not applied  
Create Left/Top Bound  
Create Right Bound  
Copy Booklet  
Covers  
Fold & Staple (optional)

Tap **[Start]** to copy.

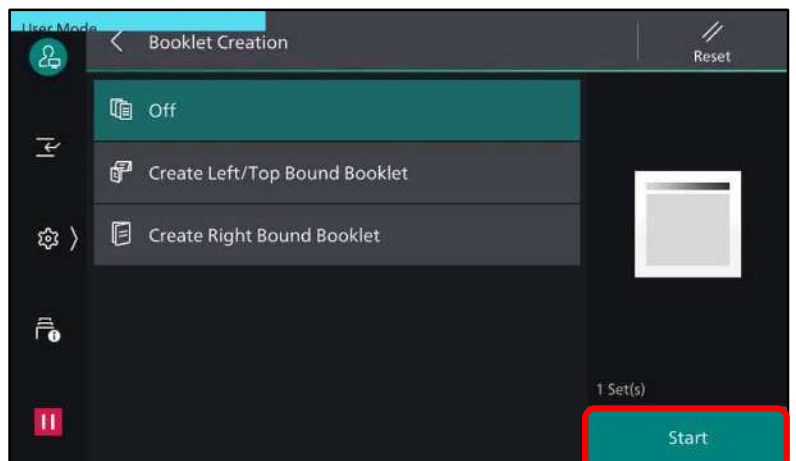

# Copy: Edge Erase...

This feature will erase the dark shadow/ dirty at the edges of document or in the center binding part of the book.



1. Load documents onto the Document Feeder or Platen Glass

2. Tap on **[Copy]** on the Services Home screen.

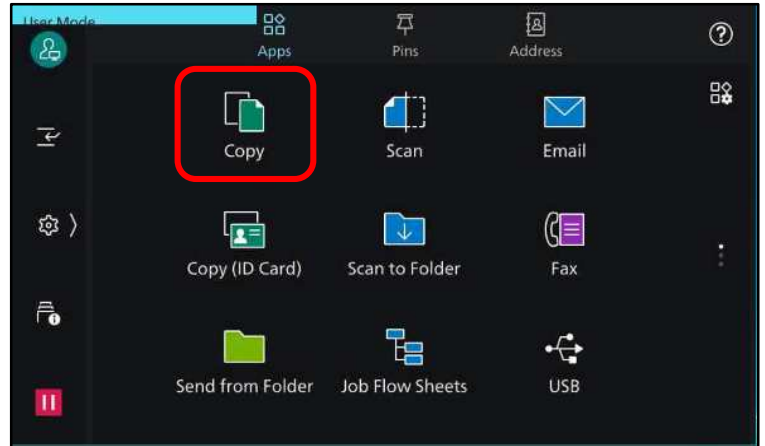

3. On the features list, scroll down to **[Edge Erase]**.

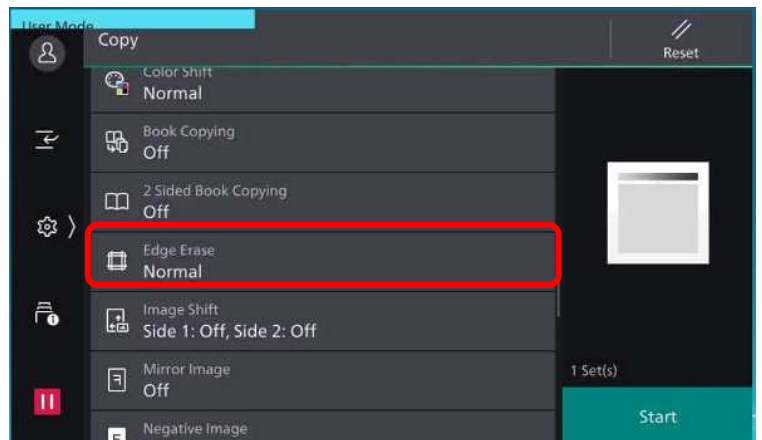

4. Choose the option, and enter the value to erase (0-50mm)

- [Normal]
- [All Edges]
- [Individual Edges]
- [Parallel Edges]

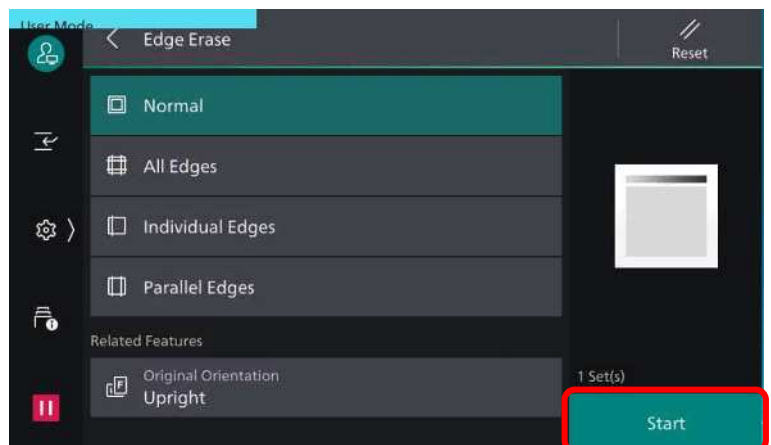

Tap **[Start]** to copy.

# Copy: ID Card Copying...

This feature copies both sides of the ID Card onto the same side of the paper.



1. Load card onto the platen glass (within A5 scan area) Close document cover.

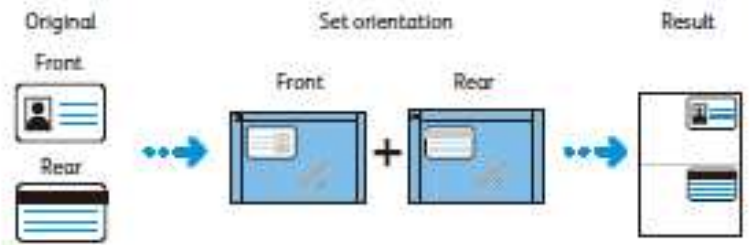

2. Select **[Copy (ID Card)]** button on the main Services Home screen.

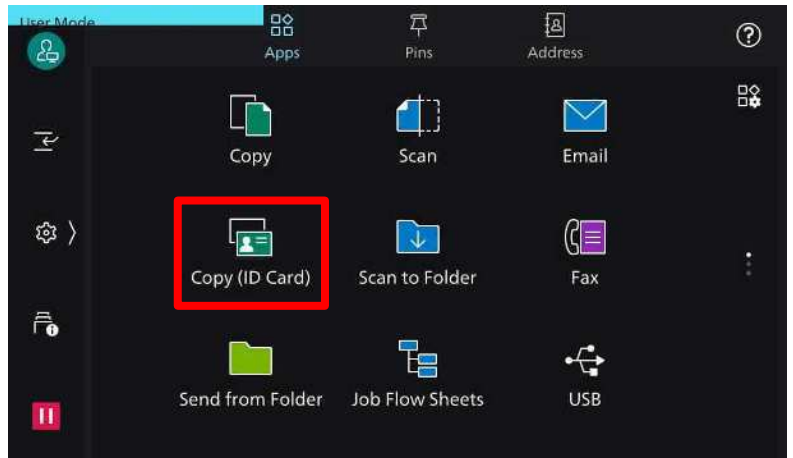

3. Set the ID card with the side to be copied facing downward, in a position at least 5mm from the top and left edge of the document glass. Press **[start]**

To copy the second side, wait for the first side to finish scanning, turn over the card, placing it slightly away from the top left corner, and then press **[start]**

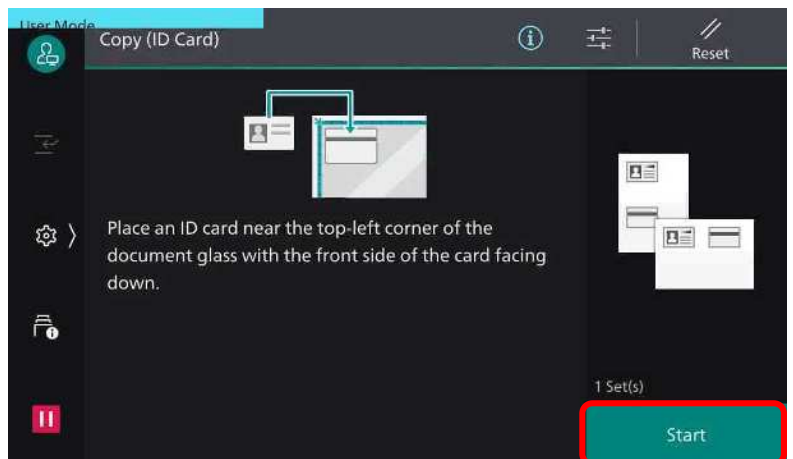

# Print: 2-sided print & Job Types

Print 2 sided documents. Sets secure print to temporarily store print data in the device with a passcode to protect your files. Files will be printed upon entering passcode.

1. From application, select **[Print]**, select the printer model, click **[Printer Properties]** / **[Preference]**.

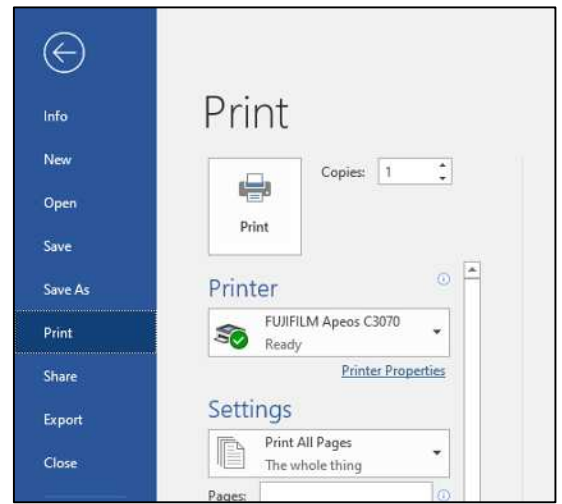

2. On the **[Basic]** tab, choose the option:

## [2 Sided Print]

Flip On Short Edge  
Flip On Long Edge

## [Job Type]

Normal Print  
Secure Print (click [Setup] button to enter (User ID & Passcode.))

For more printing options, click on other tabs

Click **[OK]** on all open windows to proceed to print.

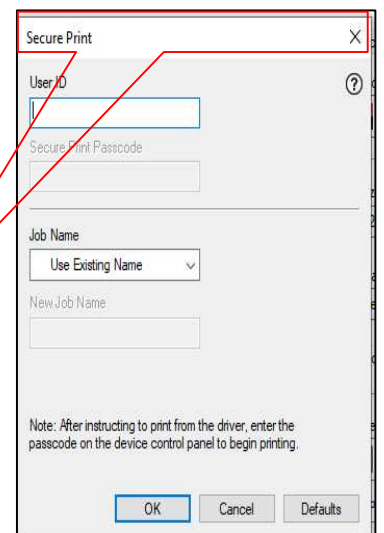
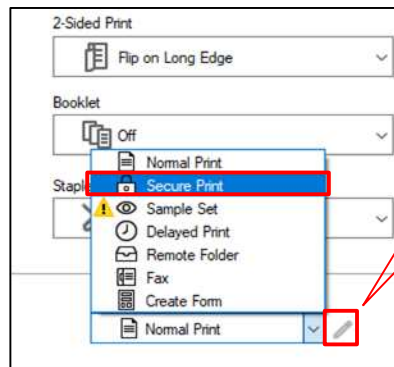
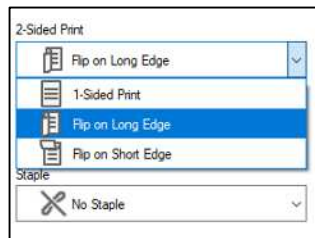
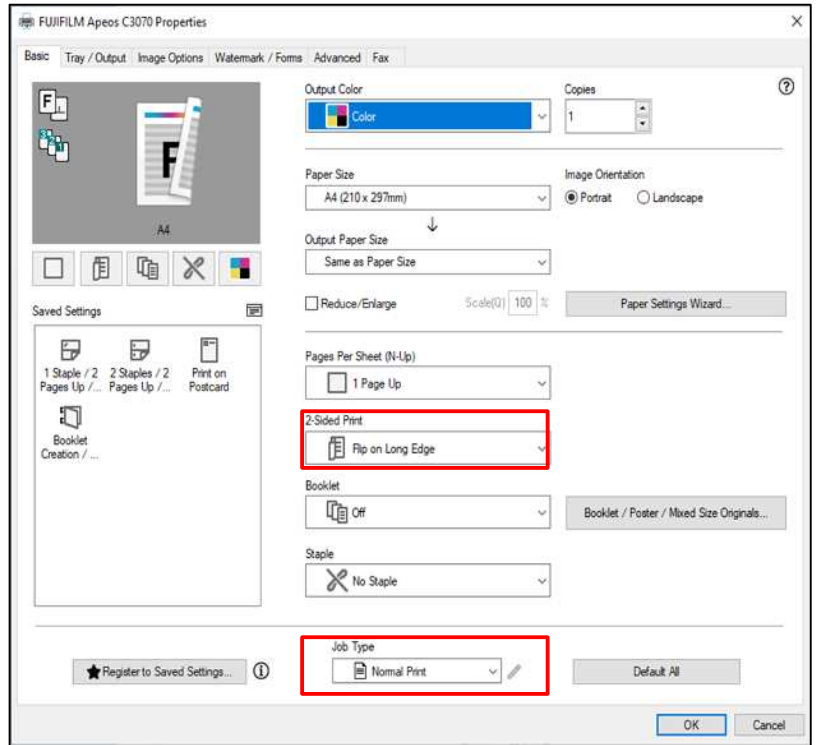

# Print: To release Secure Print jobs

Files will be printed upon entering your passcode. The following describes how to print, or delete secure print jobs

1. From machine control panel, tap  icon.

2. Tap **[stored print jobs]**.

3. Tap **[Secure Print]**

4. Select your User ID:  
If using a password, enter your passcode to continue.

5. Select required files to be printed. Enter Print Quantity and press **[Start]** to print or **[Delete]** to delete files stored in secure print folder.

4. Choose **[Print & Delete]** or **[Print & Save]**.

Or, press **[cancel]** to cancel the print job

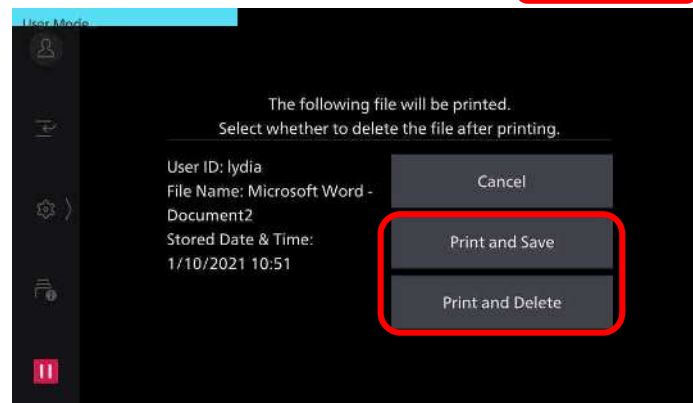
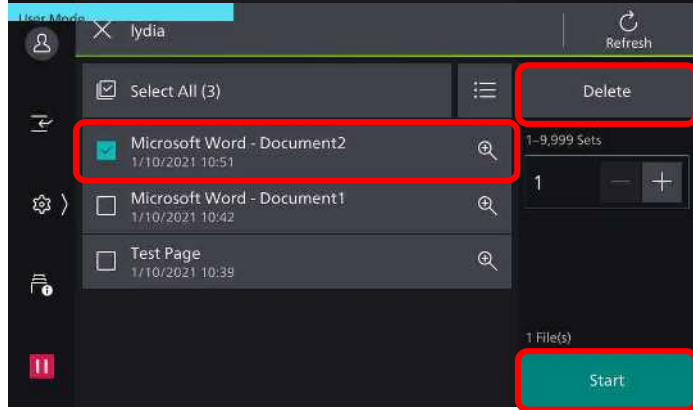
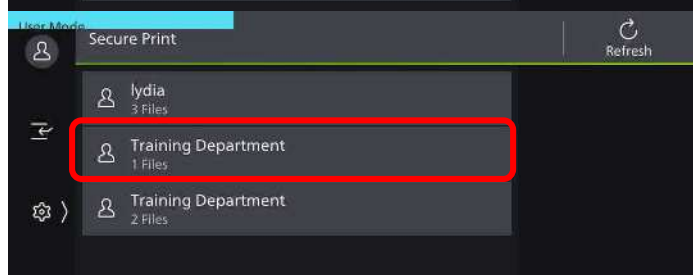
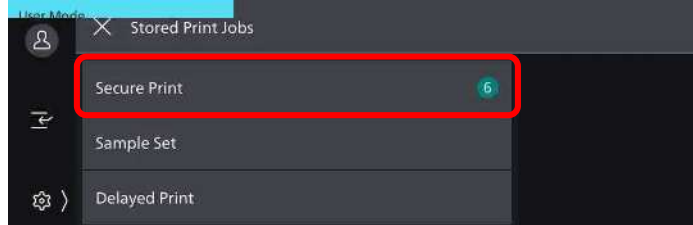
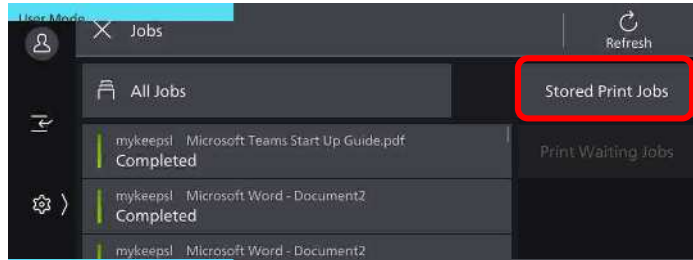
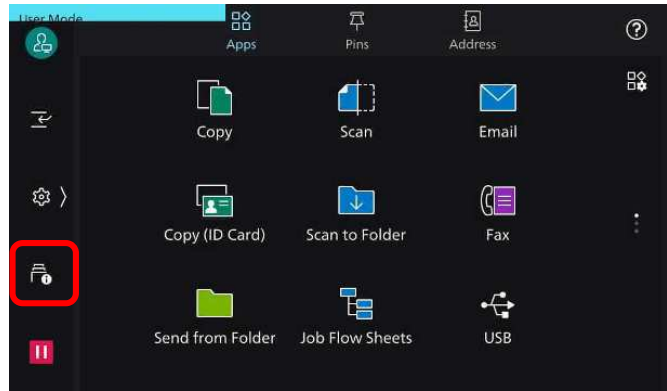

# Print: Booklet Creation (optional finisher)

Document can be printed into a 2-side multi-page booklet layout. Output can be finished with booklet finishing, fold and center stapling (optional)

1. From application, select **[Print]**, select the printer model, click **[Printer Properties] / [Preference]**.

2. From the **[Basic tab]**, select **[Booklet/Poster/Mixed Sizes Originals...]**

3. On **[Booklet /Poster/Mixed Sizes Originals...]** select options:  
 Normal  
 Poster  
 Booklet Creation

4. Select **[Booklet Creation]**  
**[Bind Edge]**  
 Left/Top Bind  
 Right/Bottom Bind  
**[Divide]**  
 Automatically Divide  
 Custom Divide  
**[Booklet Finishing]\*optional Feature**  
 Booklet Fold  
 Booklet Fold And Staple

For more printing options, click on the other tabs.

Click **[ok]** on all open windows to proceed to print.

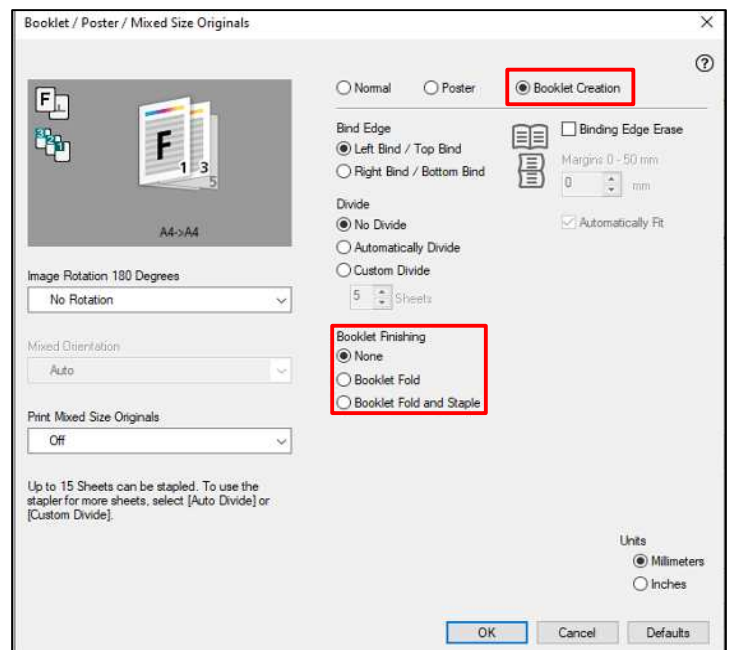
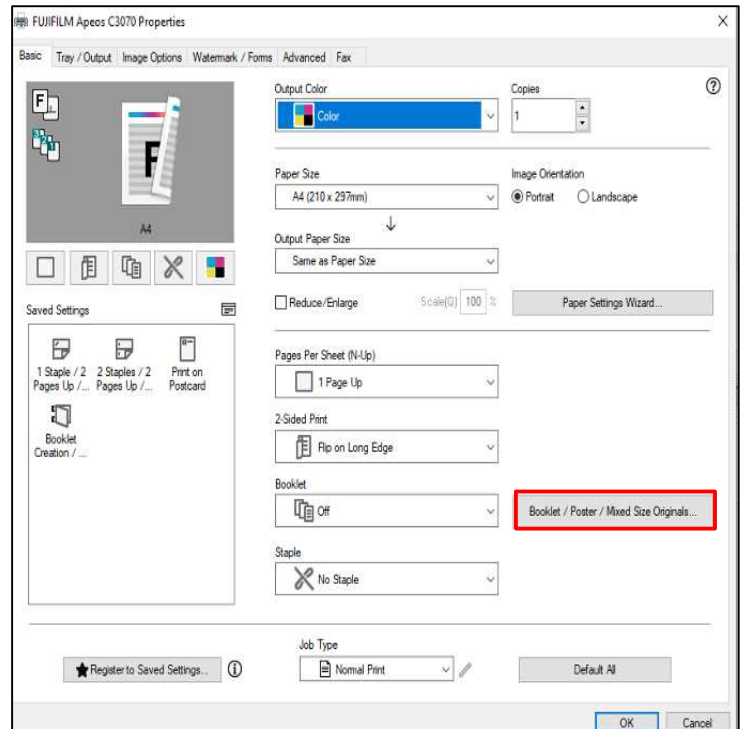
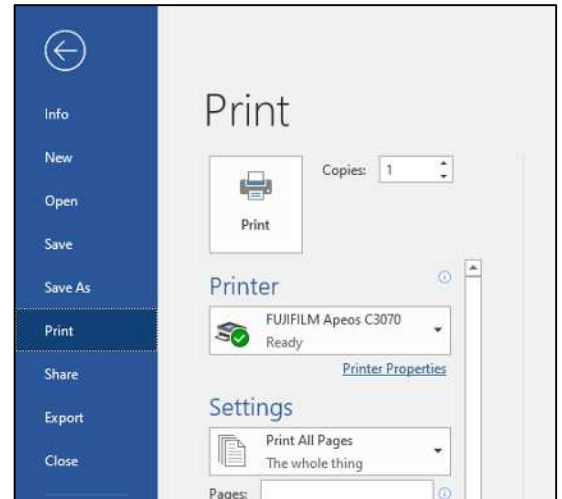

# Print: Pages per Sheet N-Up

Allows you to combine multi page document and print onto one sheet of paper

1. From application, select **[Print]**, select the printer model, click **[Printer Properties]** / **[Preference]**.

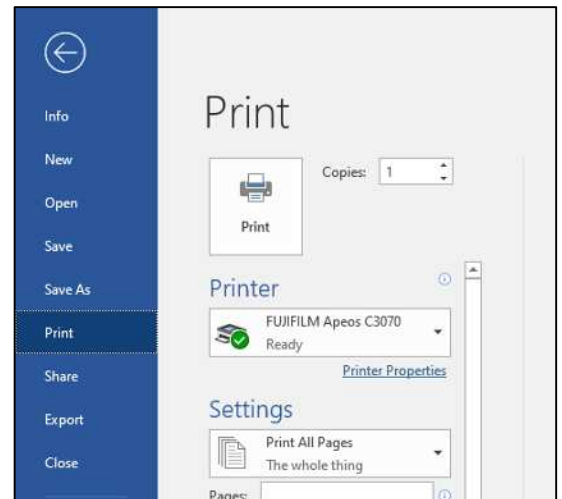

1. From the **[Basic]** tab, select options:  
**[Pages Per Sheet (N-Up)]** Choose from 2 to 32 ups.  
Select Image Order.

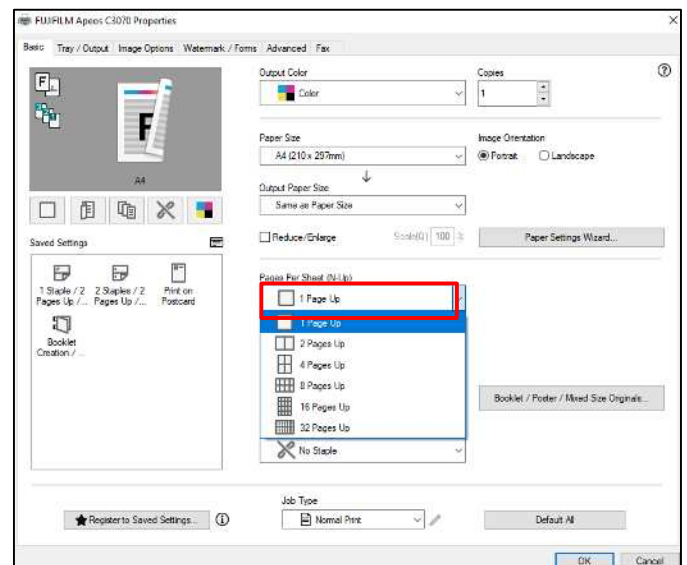

3. From the **[Basic]** tab, select options:  
**[Paper Size]**  
**[Output Paper Size]**  
**[Image Orientation]**

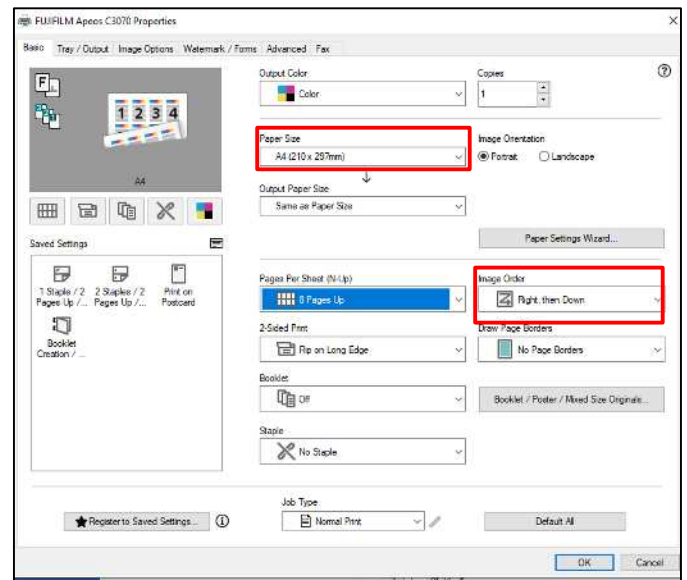

4. From the **[Tray/Output]** tab, select options:  
**[Paper Tray]**  
**[Select By Trays]**  
**[Advance Tray Settings...]**

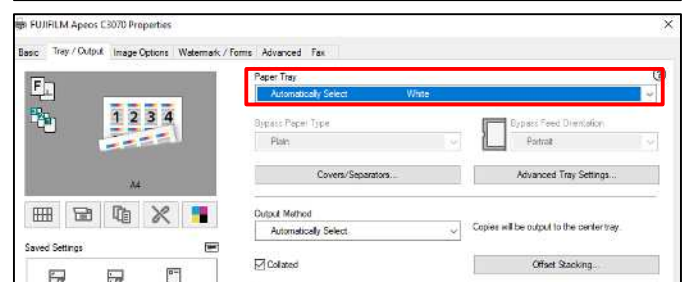

For more printing options, click on other tabs to select.

Click **[OK]** on all open windows to proceed to print.



# Print: Watermark

Document can be printed with texts such as 'confidential' over the print job

1. From application, select **[Print]**, select the printer model, click **[Printer Properties]** / **[Preference]**.

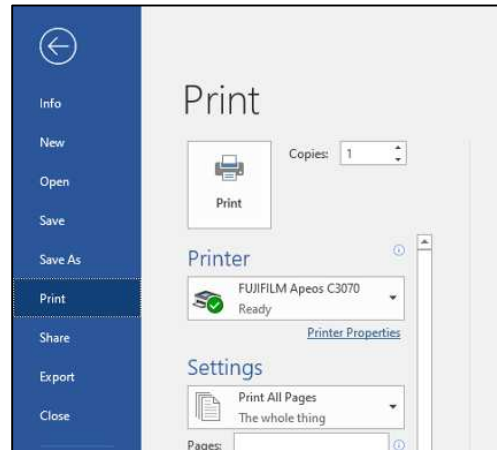

2. From the **Watermark/Form** tab, select **[Watermark]**

Choose from any preset texts or select **[New]** to create new watermark.

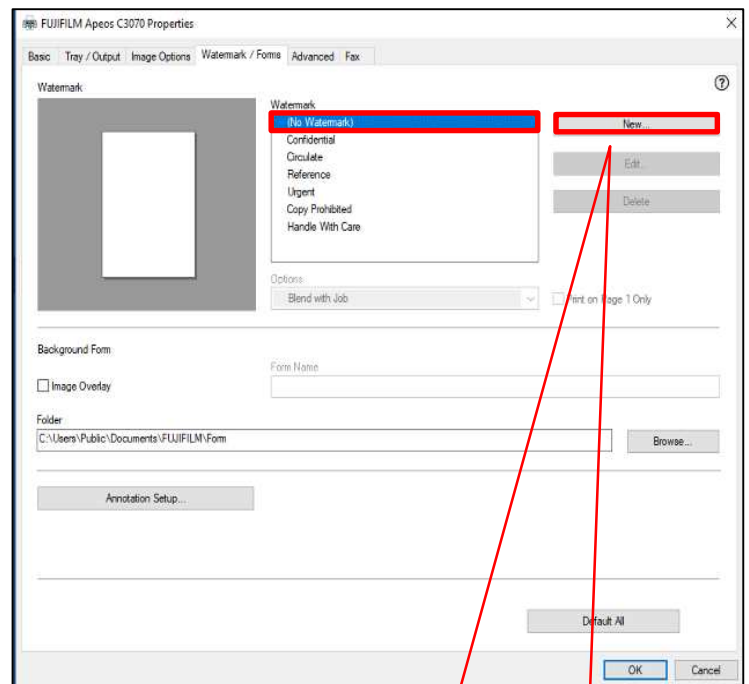

3. On the **[Watermark Editor]**  
Enter the **[name]** or **[text]**  
Set the following:  
Angle, Density, Position, Border.

Click **[OK]** to save.

For more print options, click on other tabs to select.

Click **[OK]** on all open windows to proceed to print

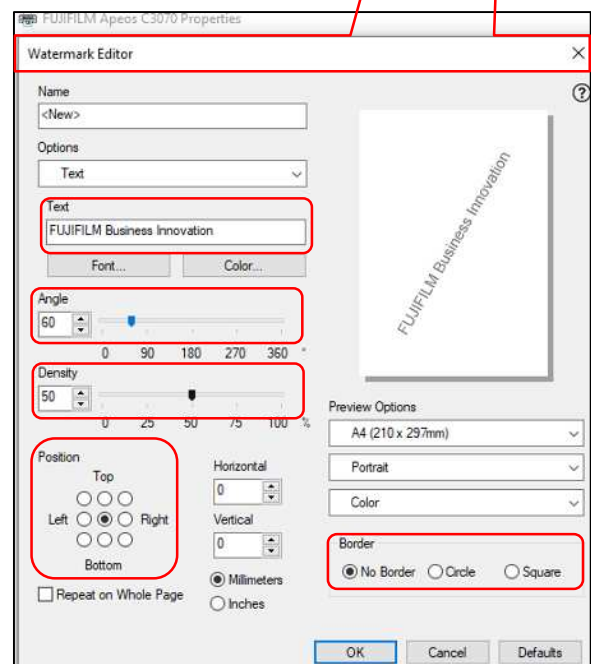

# Print: PC Fax

You can send a fax directly from your computer. Direct fax procedure may vary depending on the application you use.

1. From application, select **[Print]**, select the printer model, click **[Printer Properties]** / **[Preference]**.
2. From the **[Basic]** tab, select **[Job Type]** [Fax]

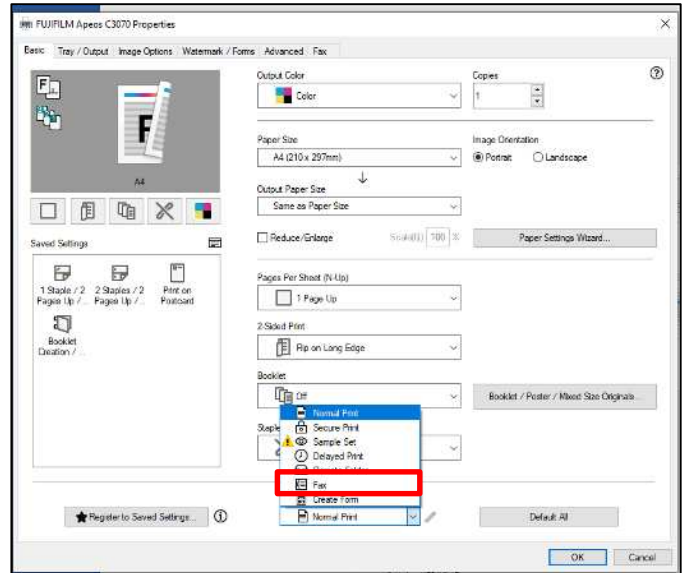
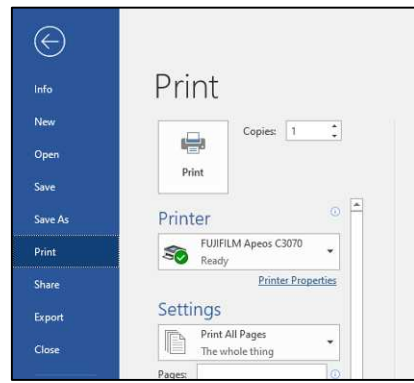

3. For more fax options, click on fax tab to select **[Fax Resolution]** **[Transmission Report]** **[Send Header]**

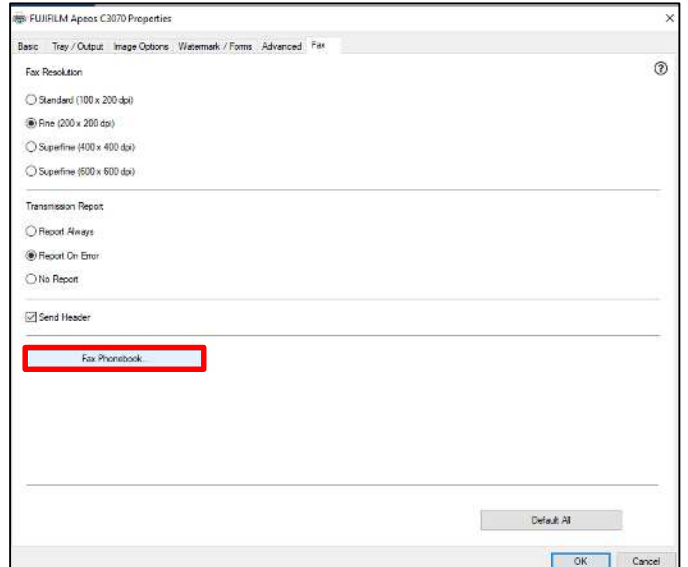

4. On the **[Fax Phonebook]**, select **[New]** to add new recipient in individual or group.

Click **[close]** to save.  
Press [ok] to proceed to fax.

To check fax jobs, press on **[Jobs]** at the machine user interface.

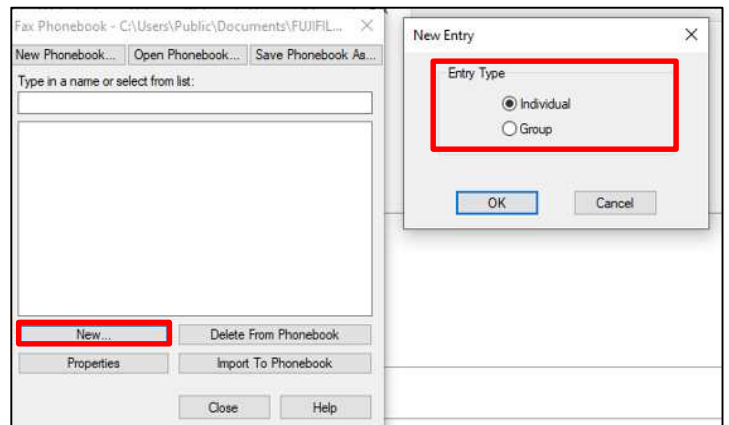

# Print: Envelope...

You can print easily on special paper types such as envelope, glossy, label with a visual image and step by step instruction.

1. From application, select **[Print]**, select the printer model, click **[Printer Properties]** / **[Preference]**.

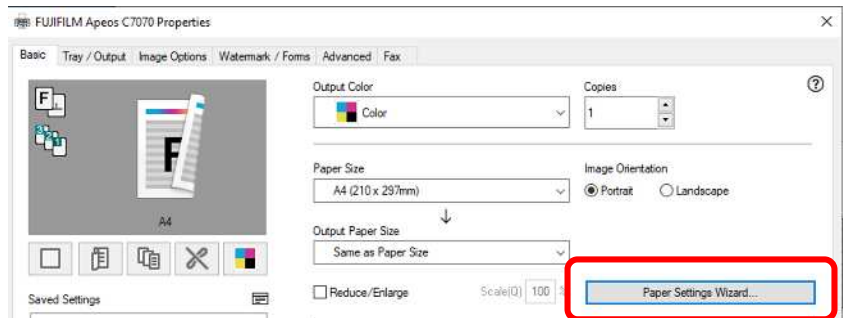

2. On the **[Basic]** tab, select **[Paper Setting Wizard]**

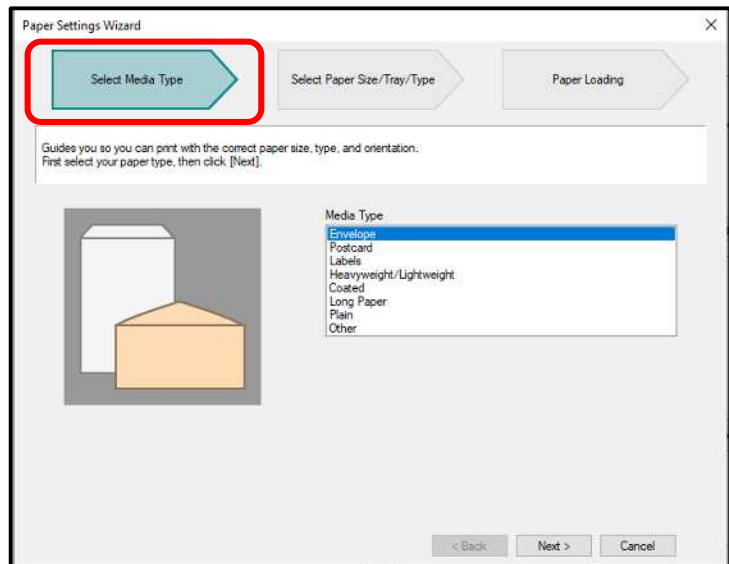

3. Select **[media type]** according to your paper type and click next to proceed

4. Select **[paper size/tray/type]** and set each item accordingly. You may also click **[custom]** to enter custom size paper

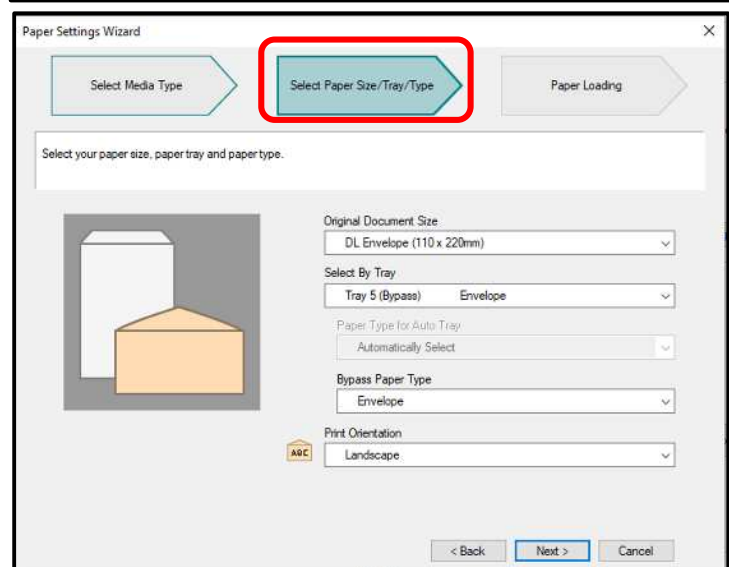

5. Select **[tray 5 (bypass)]** tray to load the paper (envelope) and click **[next]** to proceed

6. Click **[next]** to move to **[paper loading]**  
Here, a visual instruction will show how to load the document. The photo on the right will guide you how to place the paper (envelope)

Click **[Finish]** to complete the setting and exit the screens to proceed to print

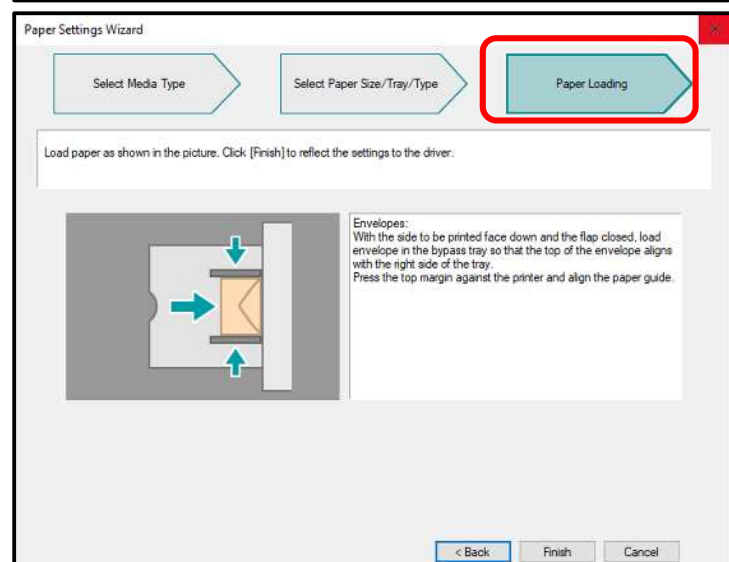

# Scan: To Email ...

Allows you to scan a document and send the scanned data as an email attachment

1. Load documents onto the Document Feeder. Tap **[Email]** icon on the Services Home screen.

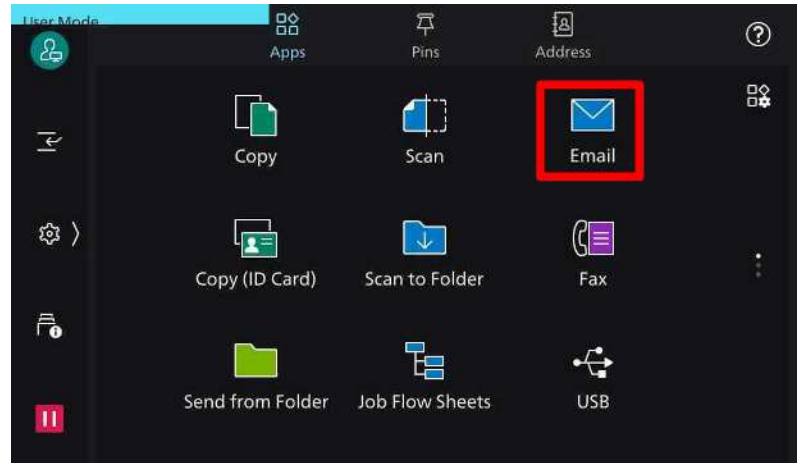

2. On the **[Email]** screen, tap **[Address Book]**. Select the recipient's name from the contact list.

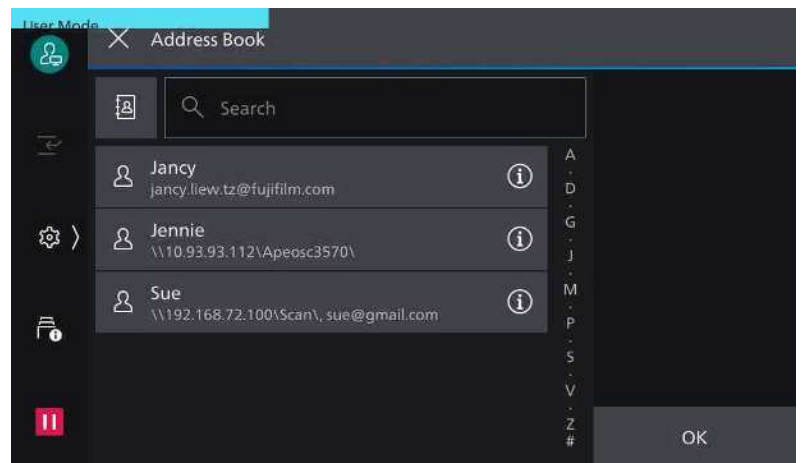

2. Tap **[≡]** on the upper side of the screen, and set desired option features

4. Select an option:
  - a: **[Color Scanning]**
  - b: **[2 Sided Scanning]**
  - c: **[File Format]**  
TIFF / JPEG / PDF / DOCUWORKS  
XPS / Microsoft Office Format\*\*  
(advanced Scan Kit is required)
  - d: **[file name]**  
to enter a specific file name

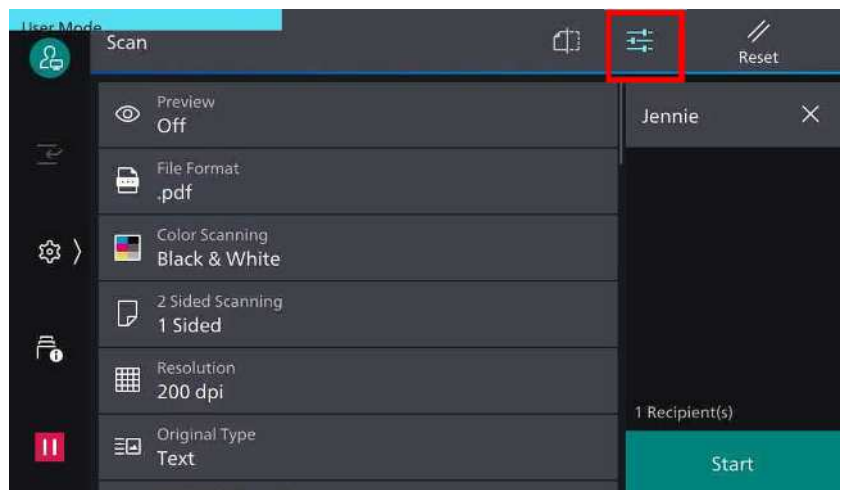

Tap **[Start]** to proceed to start scan process

# Scan: To PC

Allows you to scan a document and send the scanned data to a network computer (via SMB/FTP)

1. Load documents onto the Document Feeder.
2. Select **[Scan]** button on the Services Home screen.



3. Tap the **[Address Book]** to select the recipient and click **[OK]**

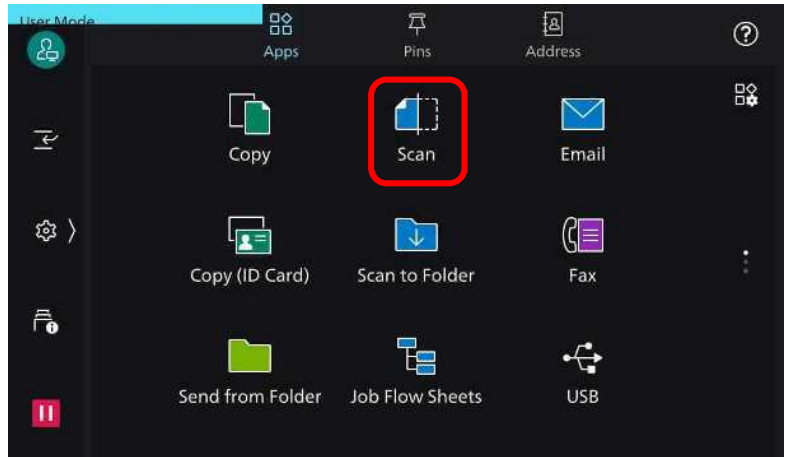

4. Tap **[Address Book]** on the upper side of the screen and set desired features.

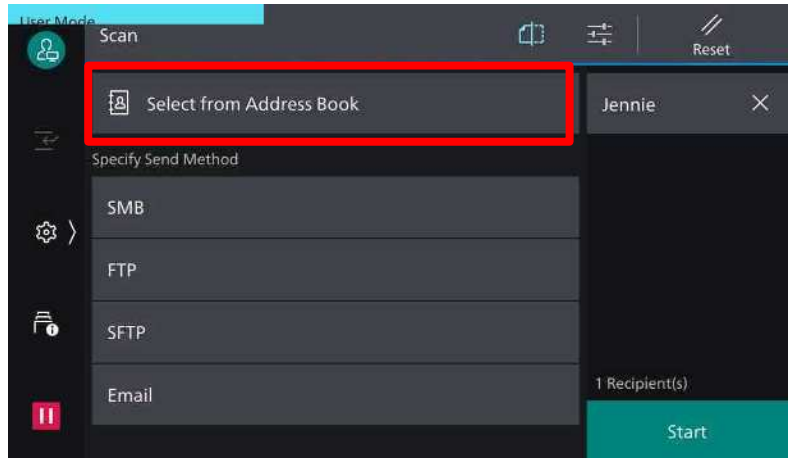

5. Select an option:
  - a: **[Color Scanning]**
  - b: **[2 Sided Scanning]**
  - c: **[File Format]**  
TIFF / JPEG / PDF / DOCUWORKS  
XPS / Microsoft Office Format\*\*  
(advanced Scan Kit is required)
  - d: **[File name]**  
to enter a specific file name

Tap **[Start]** to proceed to start scan process

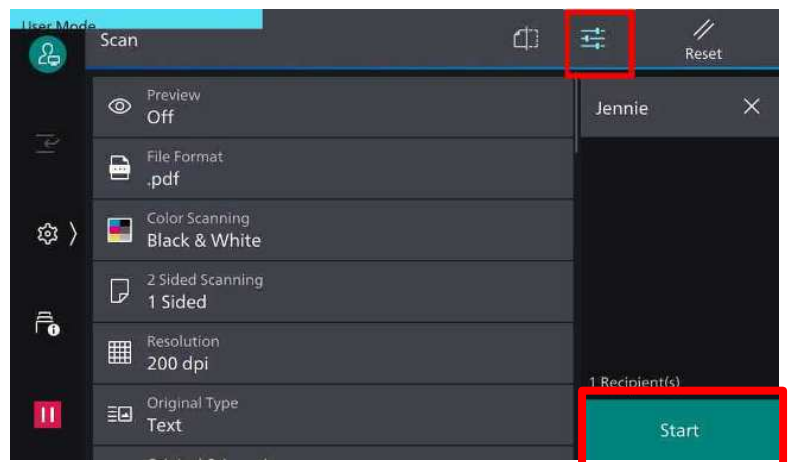

# Scan: Scan to Folder...

Allows you to scan a document and save the scanned data in a registered folder of the machine.

1. Tap **[Scan to folder]** button on the Services Home screen.
2. From the **[Scan to Folder]** screen, select a folder to save the scanned document. (Enter passcode, if any)

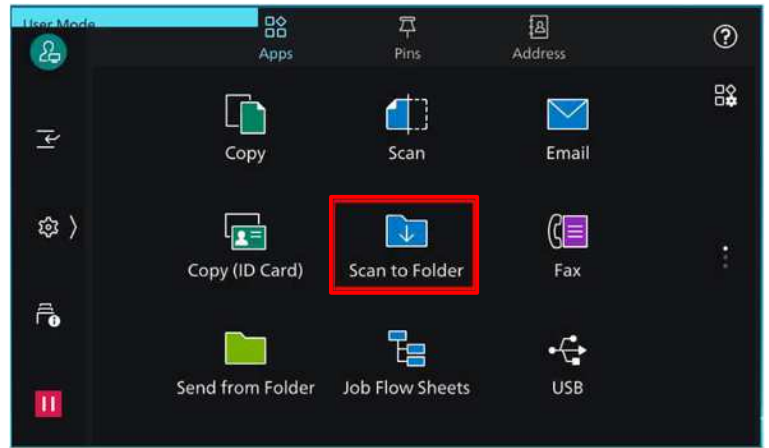

3. Tap  on the upper side of the screen, set desired features.
4. On the **[Scan to Folder]** screen. Select the option:
  - a: [Color Scanning]
  - b: [2 Sided Scanning]

Tap **[Start]** to proceed with scanning.

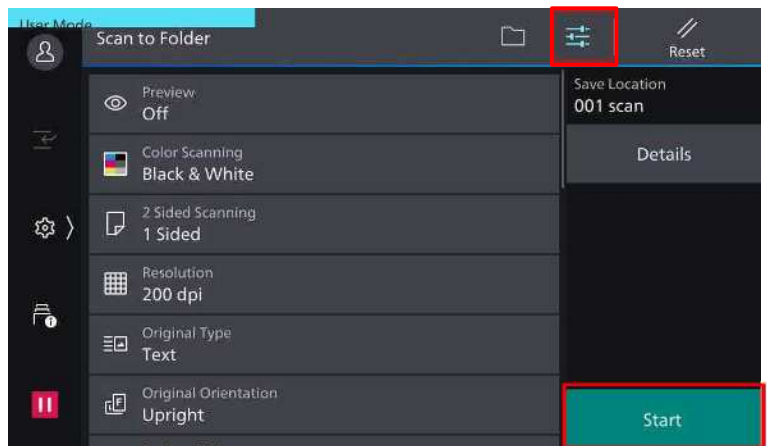
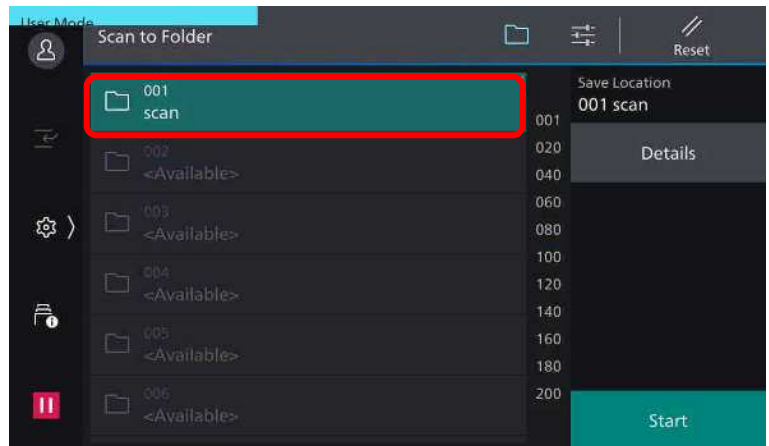

# Scan: Send from Folder...

Send to folder allows you to save the scanned document, files to be printed out.

1. Select **[Send from Folder]** button on the Service Home Screen

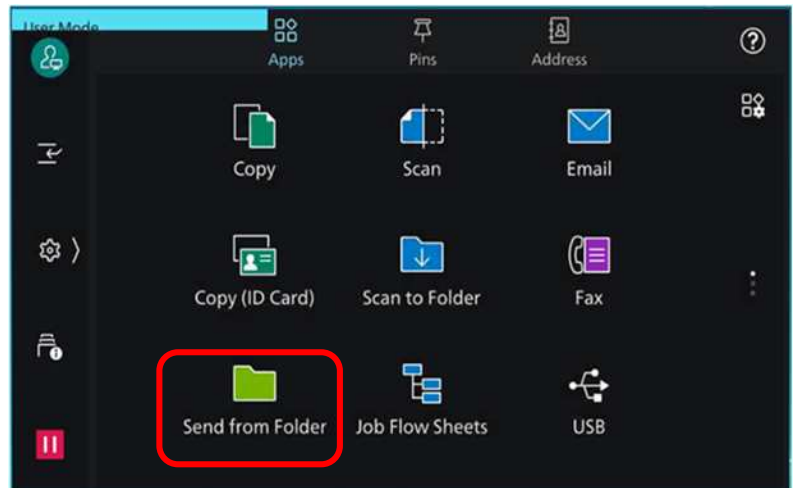

2. Select the desired folder.

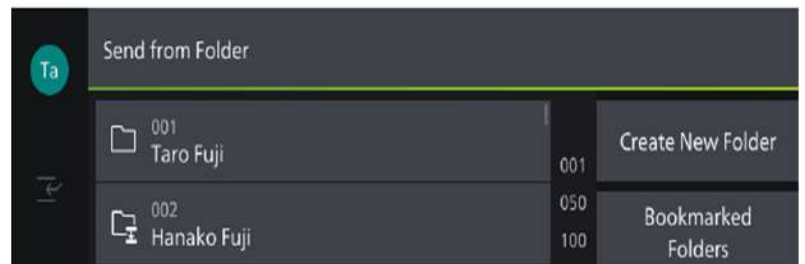

3. Select the file(s) to print and tap **[Print]**.

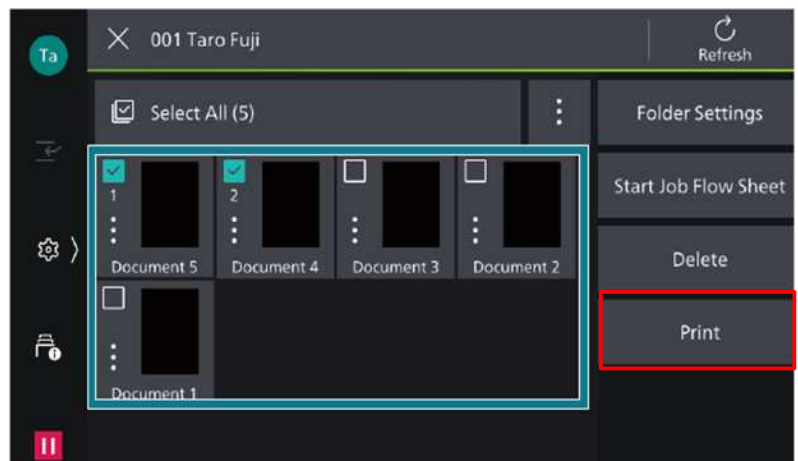

4. Select the desired feature items as needed

Tap **[Start]** to print out the document.

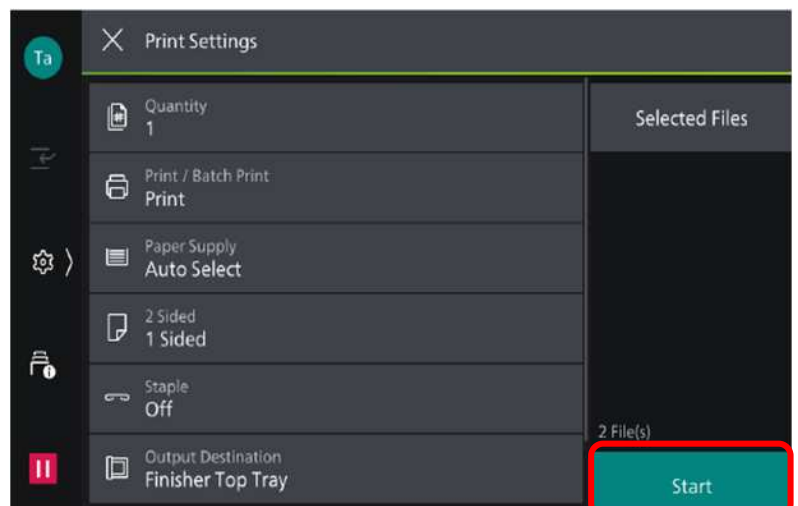

# Advance Scan: Preview, Mixed Sizes Original, Original Type...

Additional features that you can select under [E-mail], [Scan to PC], [Store to Folder], [Scan to USB]....

1. Load documents to scan. On the Services Home screen, select scan destination **[Email]**, **[Scan]**, **[Scan to Folder]**, **[Store to USB]**

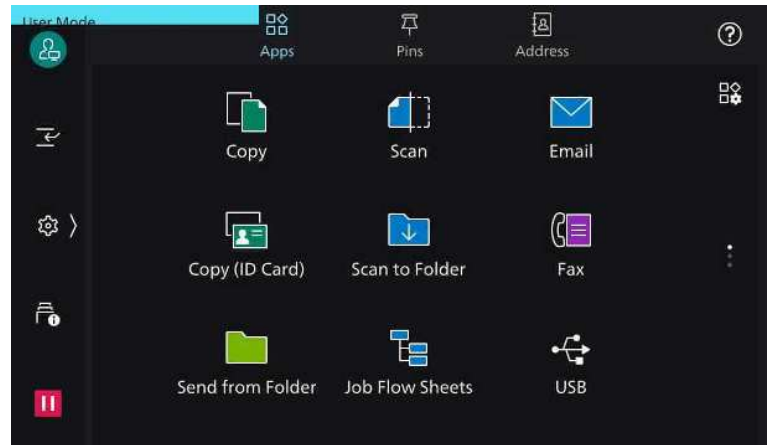

2. Tap  on the upper side of the screen, to set the desire option features.

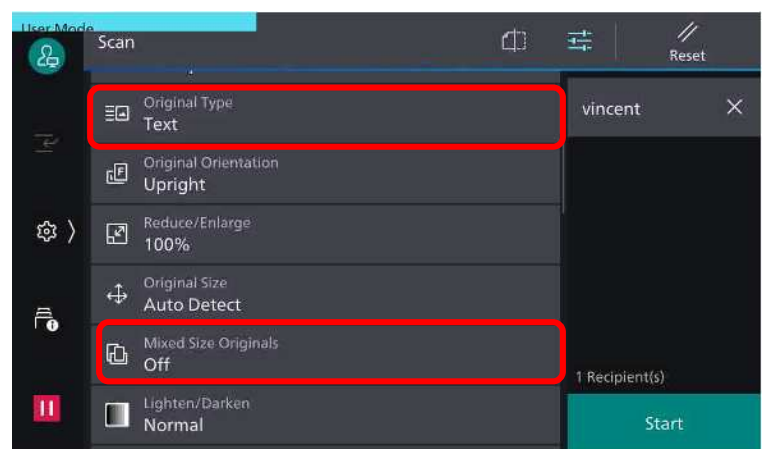

3. Select any option required:  
**a: [Preview]**  
View the scanned image before completing scan process  
**b: [Mixed Sized Originals]**  
scan different size documents simultaneously with the document feeder.  
**c: [Original Type]**  
Set the document type.

Tap **[Send (all)]** to start scanning.

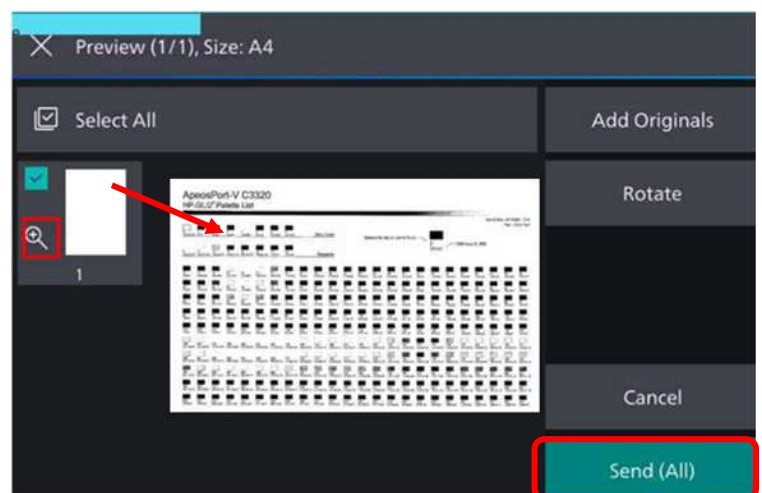



# Fax: Basic Faxing (Single/Broadcast), Faxing a 2-Sided Document

Allows to transmit a 2-sided document to single or multiple recipients in a single operation.

1. Load documents onto the Document Feeder.



2. Tap **[Fax]** on the Services Home screen.

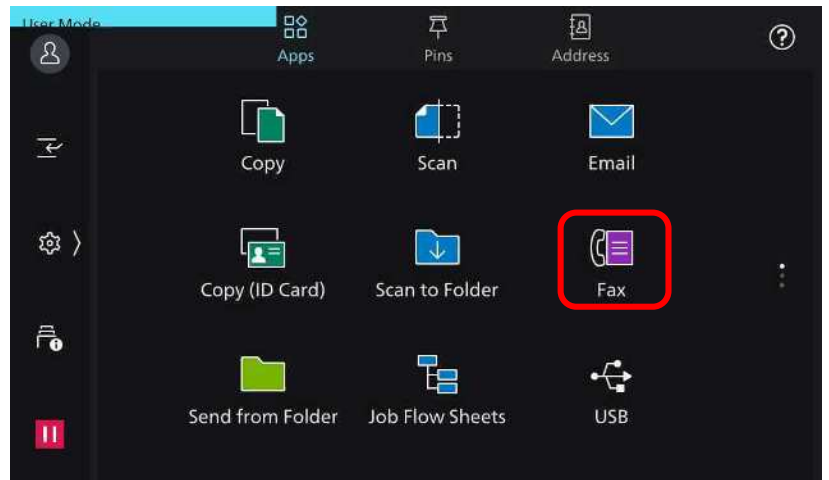

3. To enter fax recipient(s) select:  
[Numeric Keypads] or  
[Address Book]

Press **[ADD]** to enter more than one fax recipient/number.

4. Tap  to proceed with fax settings

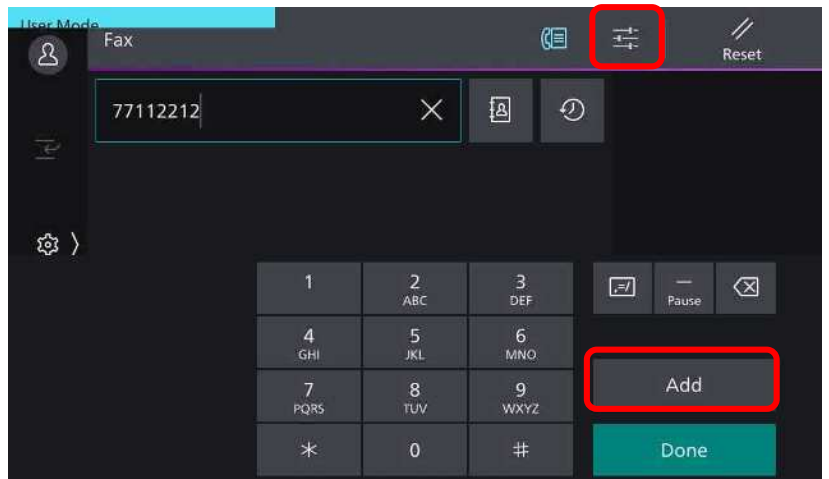

5. Select the desired options:  
**[ 2 Sided Scanning ]**  
**[ Resolution ]**  
**[ Original Type ]**

Tap **[Start]** button to begin fax process

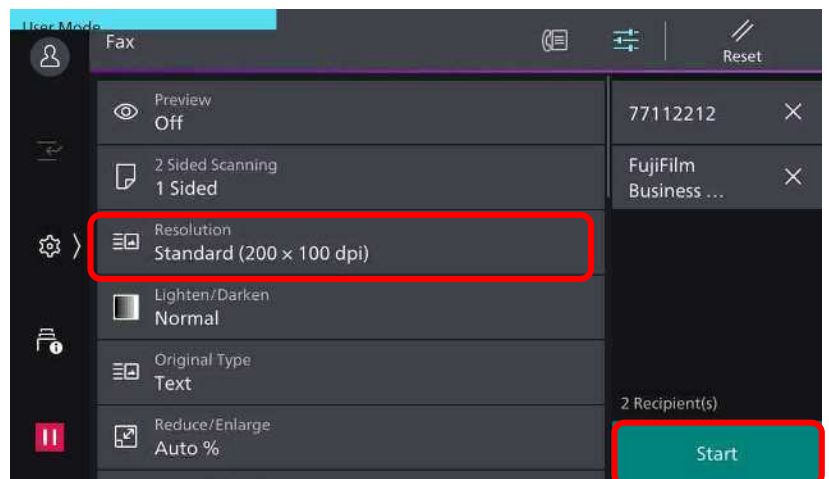

# Fax: To enable Confirmation Report

Automatically prints a transmission report when fax transmission is completed



1. Load documents onto the Document Feeder.

2. Tap **[Fax]** on the Services Home screen.

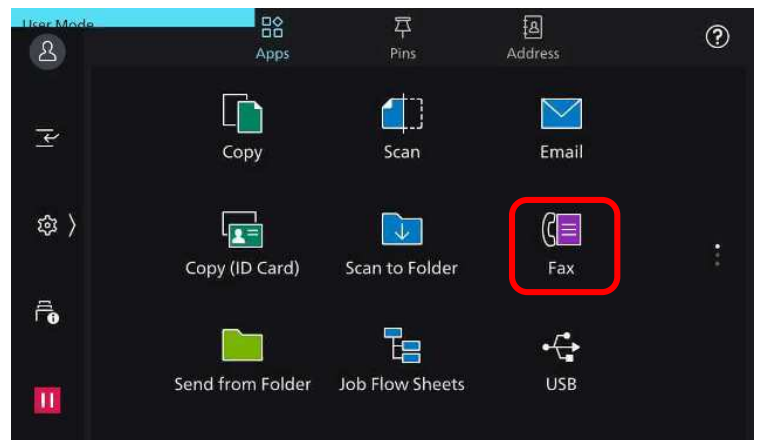

3. Click on **[Settings]** and scroll to **[transmission report]**

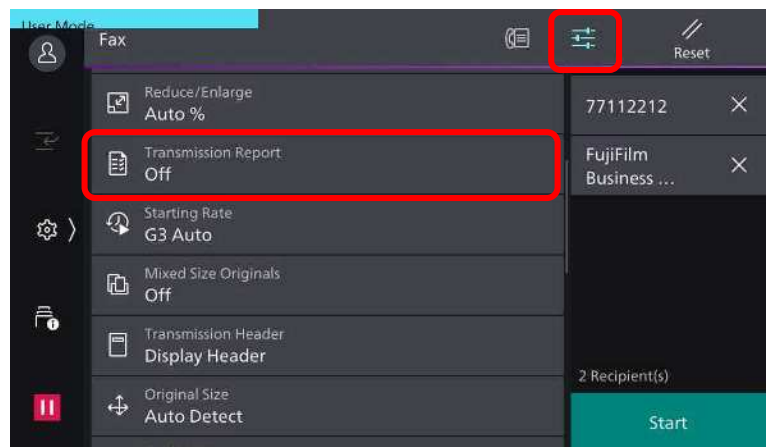

4. Tap **[on]** to enable transmission report

Tap **[Start]** button to begin fax process

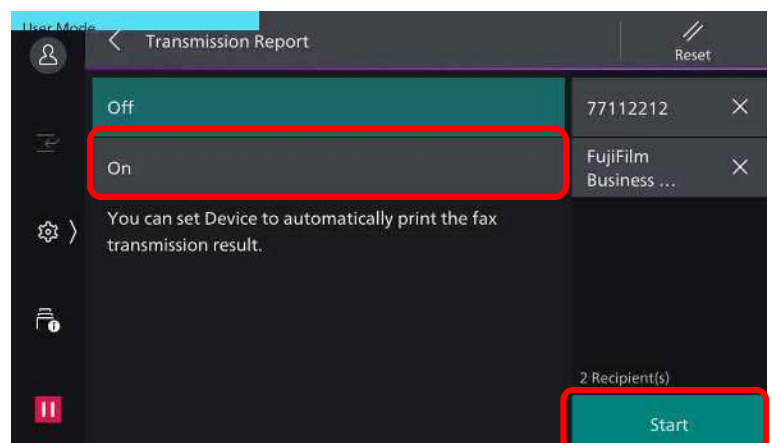

# USB: Print from USB ...

Data/Files stored in the USB (2.0) can be printed from the device. Supportable / Recognized files are PDF, JPEG, TIFF, XDW,

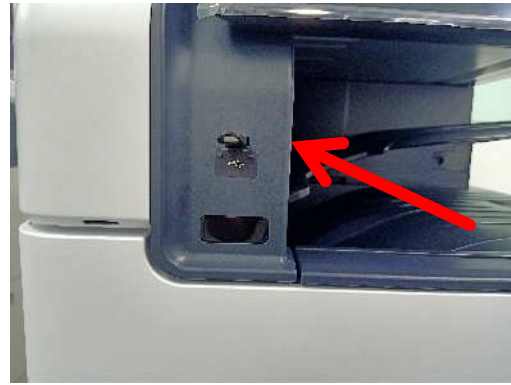

1. Insert the USB memory device into the memory slot.

2. The following screen displays upon detected USB device  
**a. Scan To USB**  
**b. Print from USB**

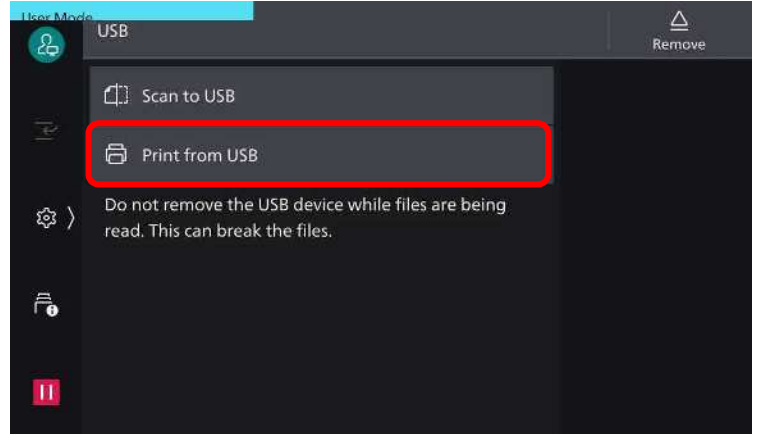

3. Tap **[Print from USB]**

4. Select the required file to be printed

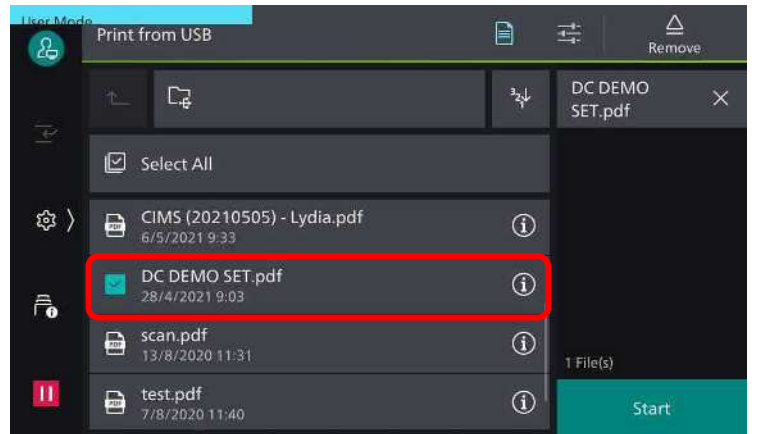

5. Tap  to select the desired print options:  
**a: [Output Color]**  
**b: [Paper Supply]**  
**c: [2 Sided]**

Tap **[Start]** to proceed.

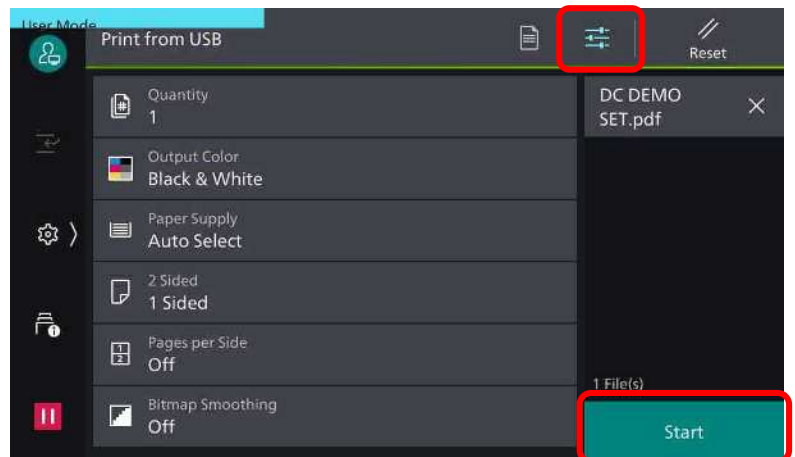

# USB: Scan to USB ...

Allows you to scan and stored the scanned data to a USB memory device

1. Insert the USB memory device into the memory slot.

Note: If the pop up message "USB media has been inserted" is not displayed, tap the [USB] icon on the home screen instead

2. Load documents on the Feeder or Platen Glass.

3. The following screen displays upon USB device detected:
  - a. **Scan To USB**
  - b. **Print from USB**



4. Select the destination folder to scan

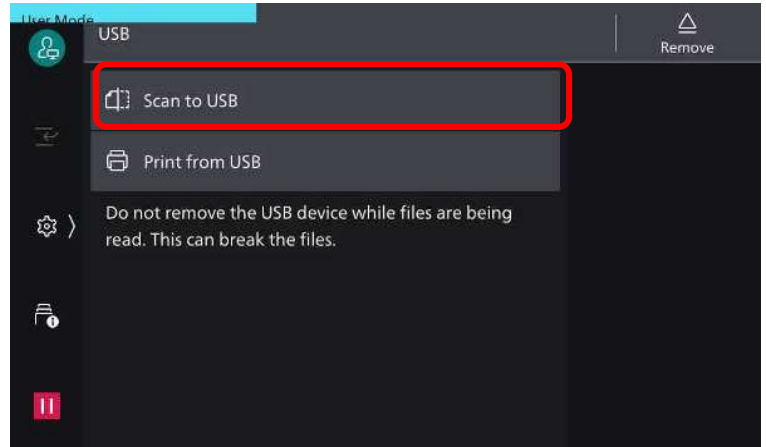

- 5) Tap [ ] and select desired option
  - a: [Colour Scanning]
  - b: [2-Sided Scanning]
  - c: [File Format]
  - d: [Original Type]

Tap [Start] button to proceed.

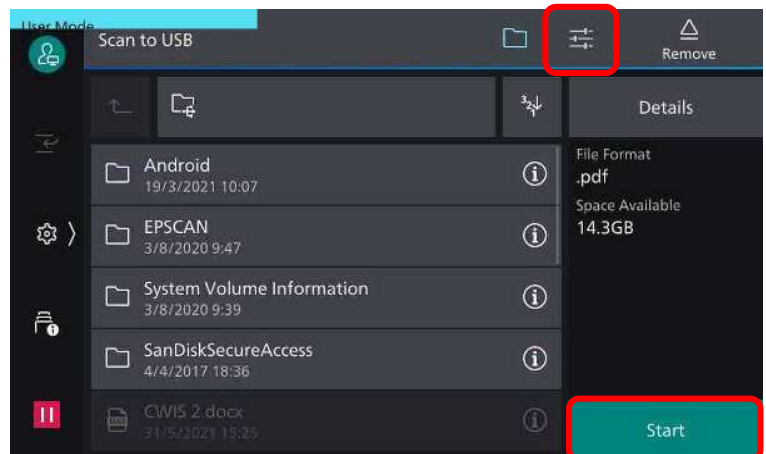
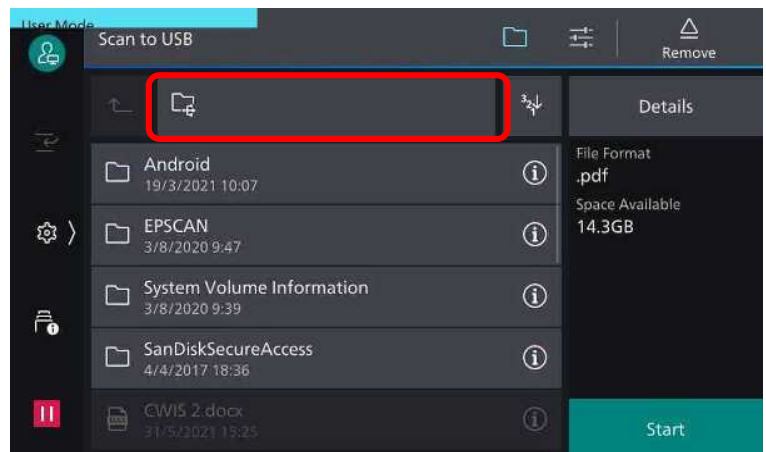

# Mobile Printing

Allows you to print & scan directly from your mobile via FUJIFILM Print Utility app

1. Download the **'Print Utility V3'** app via **'Google Play'** or Apple **'App Store'**
2. Launch the application and register the machine by tapping **[tap here to register]** on the bottom of the screen.  
(Wi-Fi will auto detect and display the device name and model)



3. From the main menu, select the desired features, and choose a file or document to be printed supported file format: TIFF, JPEG, PDF

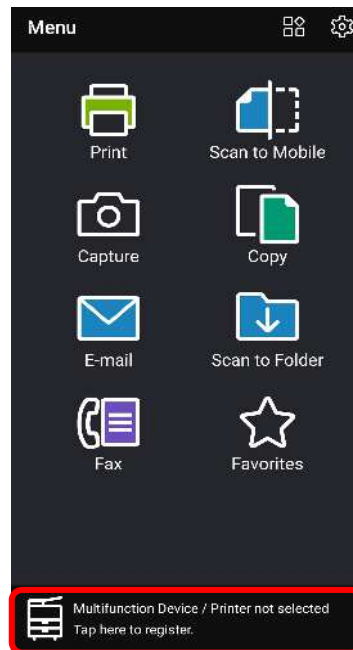

4. Under the **[advanced]**, tap on the desired settings.

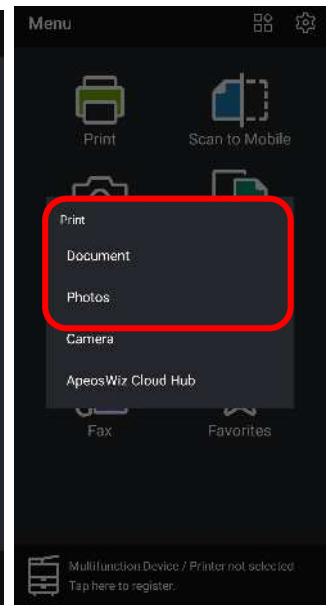
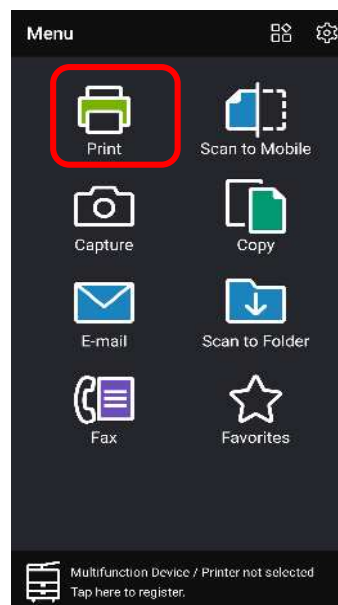

Tap **[start]** to start the print job

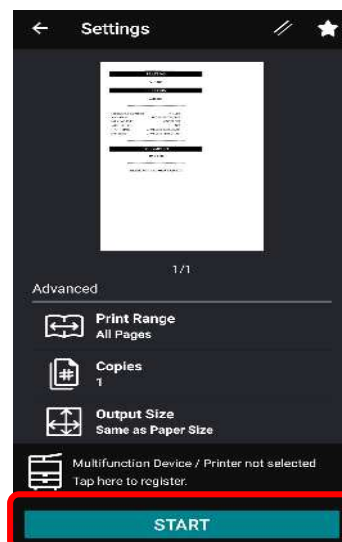

# Maintenance : Clearing Paper Jams

NOTE: Follow instructions displayed on the Touch Screen to remove the jammed paper.

## Paper Jam in the Document Feeder (DADF)



1) Pull up the front handle of the cover and open the cover until it stops.

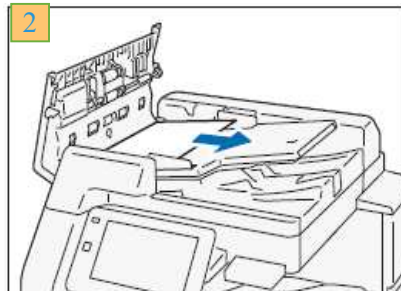

2) Remove the document.

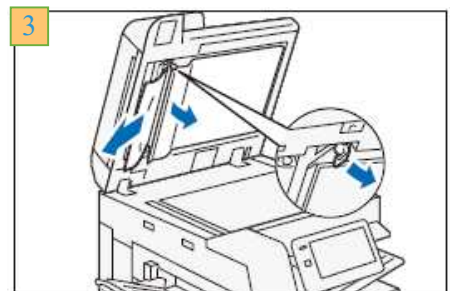

3) Open the document cover, grip the lever to open the side 2 scanner, and remove the document.



4) Lift the document feeder tray and remove the document.

## Scanner: Document cover, document glass, film, scanner glass

Wipe off any dirt with the supplied cloth about once a month. When stains cannot be removed easily, wipe them lightly with the soft cloth slightly moisten with a thin neutral detergent solution

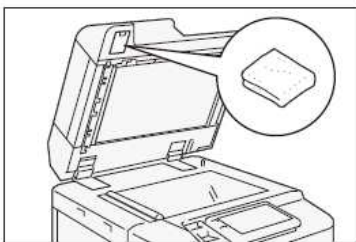

1) Wipe any dirt and dust using the supplied soft cloth

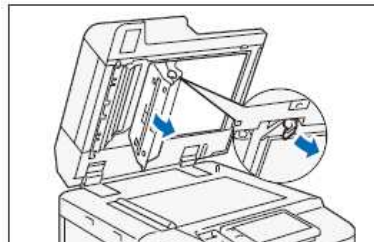

2) Open the document cover, and grip the handle to open the side 2 scanner

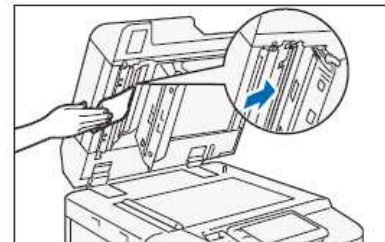

3) Wipe off any dirt from the film

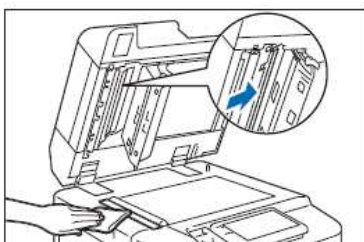

4) Wipe off any dirt from the platen glass. Close the side 2 scanner, then close the document cover

# Maintenance : Clearing Paper Jams

**NOTE:** Follow instructions displayed on the Touch Screen to remove the jammed paper.

## Paper Jam in the Transfer Unit



1) Pull up the front handle of the cover and open the cover until it stops.

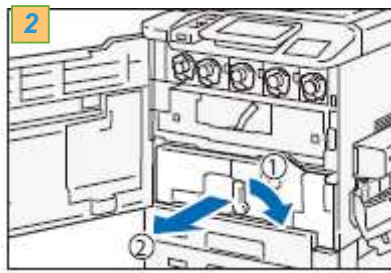

2) Turn the handle [2] of the Transfer Unit to the right and pull the Transfer Unit out to the front until it stops

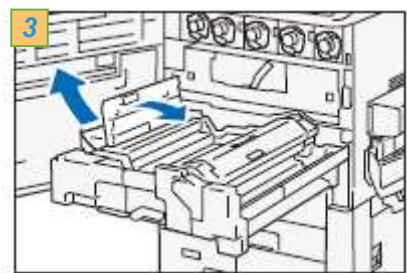

3) Slowly pull out the paper in the arrow direction and remove it.

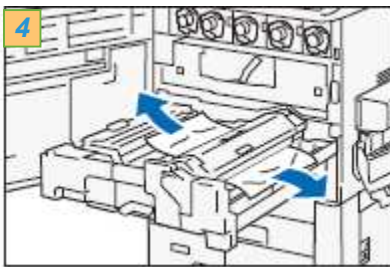

4) Open the handle [2a] and remove the jammed paper.

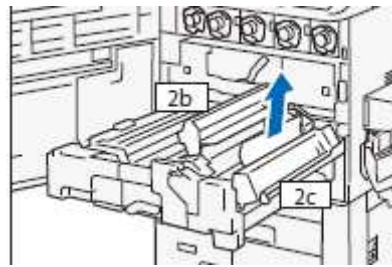

5) Return the handle [2b] and handle [2c].

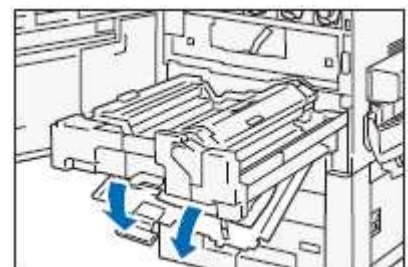

6) Open the handle [2d] down and remove the jammed paper. Return the handle [2d]. Push the Transfer Unit to the rearmost position and turn the handle [2] to the left. Close the Front Cover.

## Paper Jam in Lower Left & Lower Right Cover

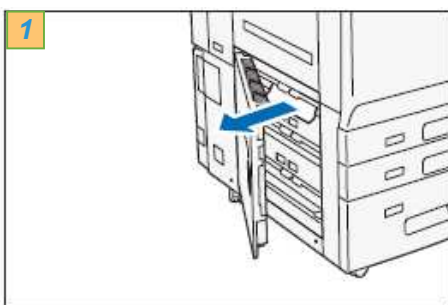

1) Open the Lower Left Cover. Remove the jammed paper. Close the lower left cover

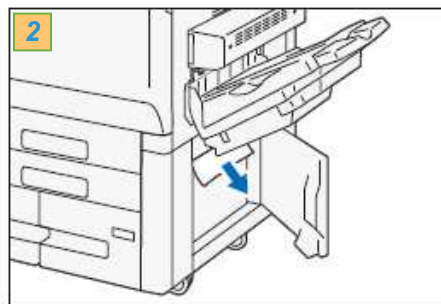

2) Open the Lower Right Cover. Remove the jammed paper. Close the lower right cover.

# Maintenance: Clearing Paper Jams

Note: Follow instructions displayed on the Touch Screen to remove the jammed paper.

Warning! The machine parts are very hot to touch and remove. Never touch a labeled area indicating 'High Temperature' and 'Caution' to avoid burns.

## Paper Jam in Tray 1 and 2

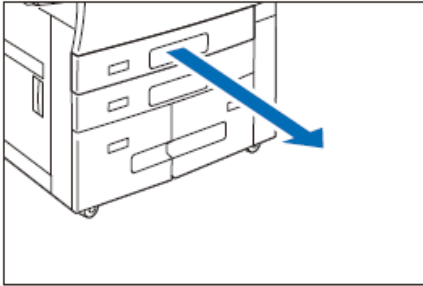

1. Pull out the Paper Tray where the paper jam occurred until it stops

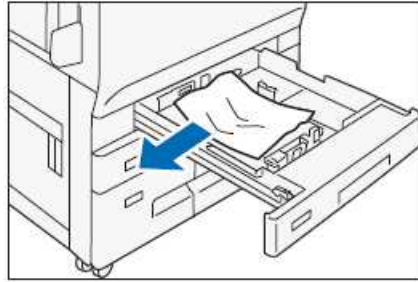

2. Remove the jammed paper. Push back the paper tray till it closes

## Paper Jam in Tray 3 and 4

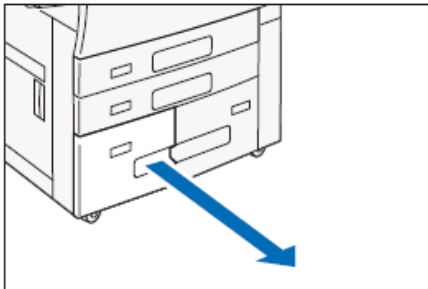

1. Pull out the paper tray where the paper jam occurred until it stops.

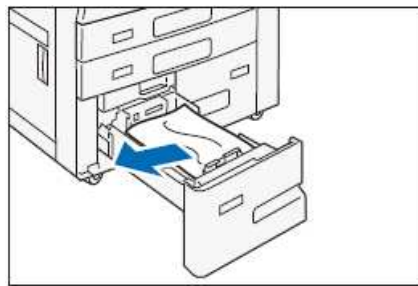

2. Remove the jammed paper.

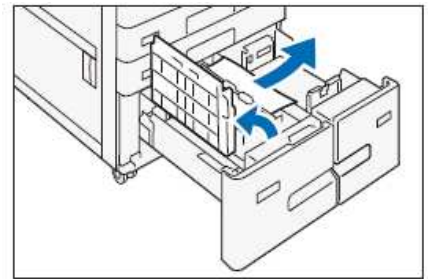

3. Pull out tray 3 and tray 4. Pull out the unit, then open the handle and remove the jammed paper. Close the handle and push back the paper tray until it closes.

## Tray 5 (Bypass)

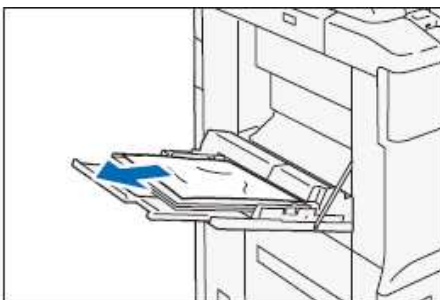

1. Remove all the jammed paper from the bypass tray, and then load the paper again



# Maintenance : Replacing Consumables

Note: The machine will prompt a message when it is time to order a new Toner Cartridge.

## Replacing Toner Container

**Caution:** Place a few sheets of paper on the floor before removing the cartridge.

This will allow any excess Toner to fall on the paper.

Replace Toner Cartridges while the machine powered ON.

Powering the machine OFF will erase all information stored in the machine's memory.

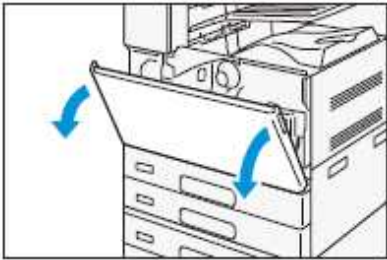

1. Ensure the machine is not operating, before opening the Front Cover.

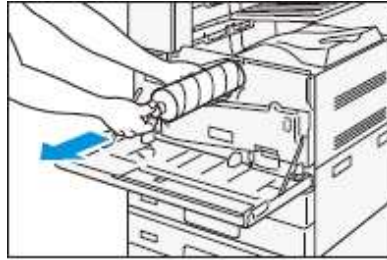

2. Place your hand under the toner cartridge and slowly pull out the toner cartridge. Gently shake the cartridge

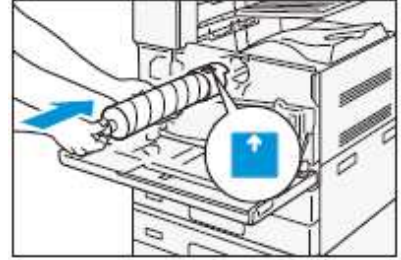

3. Orient the toner cartridge with the arrow facing up and insert the cartridge until it stops. Close the front cover

## Replacing Waste Toner Container

**Caution:** Do not use warm water or cleaning solvents to remove Toner (Dry Ink) from your skin or clothing.

This will set the Toner and make it difficult to remove.

If any Toner gets on your skin or clothing, use a brush to remove the Toner, blow it off, or wash it off with cold water and mild soap.

Do not attempt to use a standard shop vacuum or home vacuum to clean Toner spills in or near the machine.

Shop and home vacuums are not equipped with correct filtration and will contaminate your environment.



1. Ensure that the machine is not operating, and open the front cover

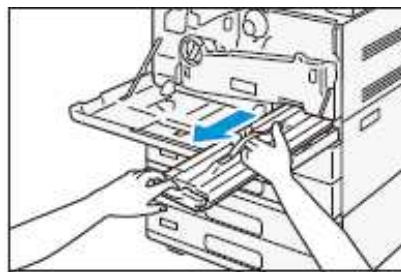

2. Hold the handle of the waste tone container and take out the waste toner container.

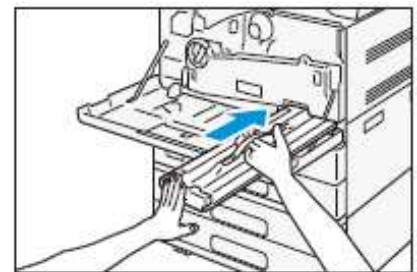

3. Hold the handle of the new waste toner container and slowly push in the waste toner until you hear a 'click' sound. Close the front cover.

# Maintenance: Replacing Consumables

## Replacing R1 Finisher Staple Cartridge

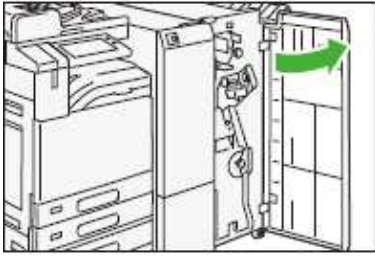

1: Ensure the machine is idle before opening the Finisher Door.

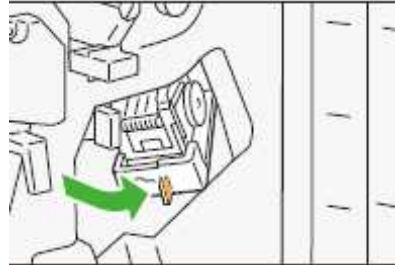

2: Hold [R1] and move the stapler unit to the front



3: Hold the lever and remove the cartridge

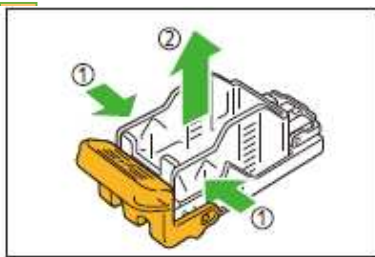

4: Pinch both sides of the empty staple case (1) and remove from the cartridge (2)

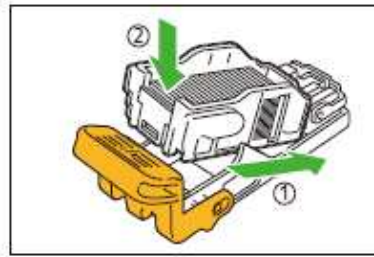

5: Insert a new staple case into the cartridge (1) and push the back side (2)

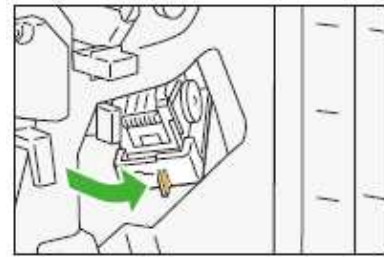

6: Insert the cartridge into the machine. Close the Finisher Front Door.

## Replacing R2 & R3 Booklet Staple Cartridges

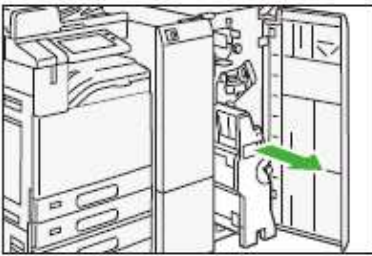

1: Open the Finisher Door, hold and pull out the cartridge lever



2: Pull out the stapling unit.



3: Push the orange buttons on either side of the cartridge (1) and open the cover (2). Push the metal part of the cartridge up

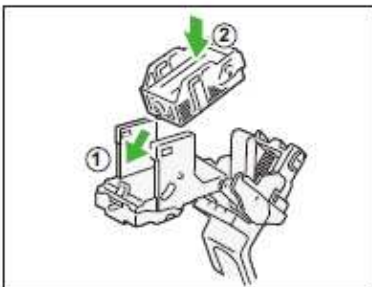

4: Insert a new staple case (1) and push the back side to set in place (2)

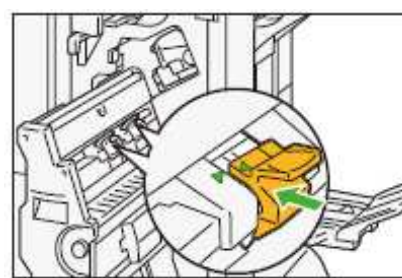

5: Insert the cartridge into the original position, insert the booklet maker all the way. Close the cover.

# Machine Status

## Billing Information

On the Machine Panel, tap  icon.  
Select <Device status>, <Billing Information>

**Important:**  
Billing Information is different from the [Usage Counters](#) in CWIS properties.

User should submit meter readings based on the meter from machine UI / Touch Screen.

- Color Impressions :** Total full color (Copies + Prints)
- Black Impressions :** Total B/W (Copies + Prints + Faxes)
- Color Large Impressions :** Total large-size full color (Copies + Prints)
- Total Impressions :** Total of Color Impressions + Black Impressions

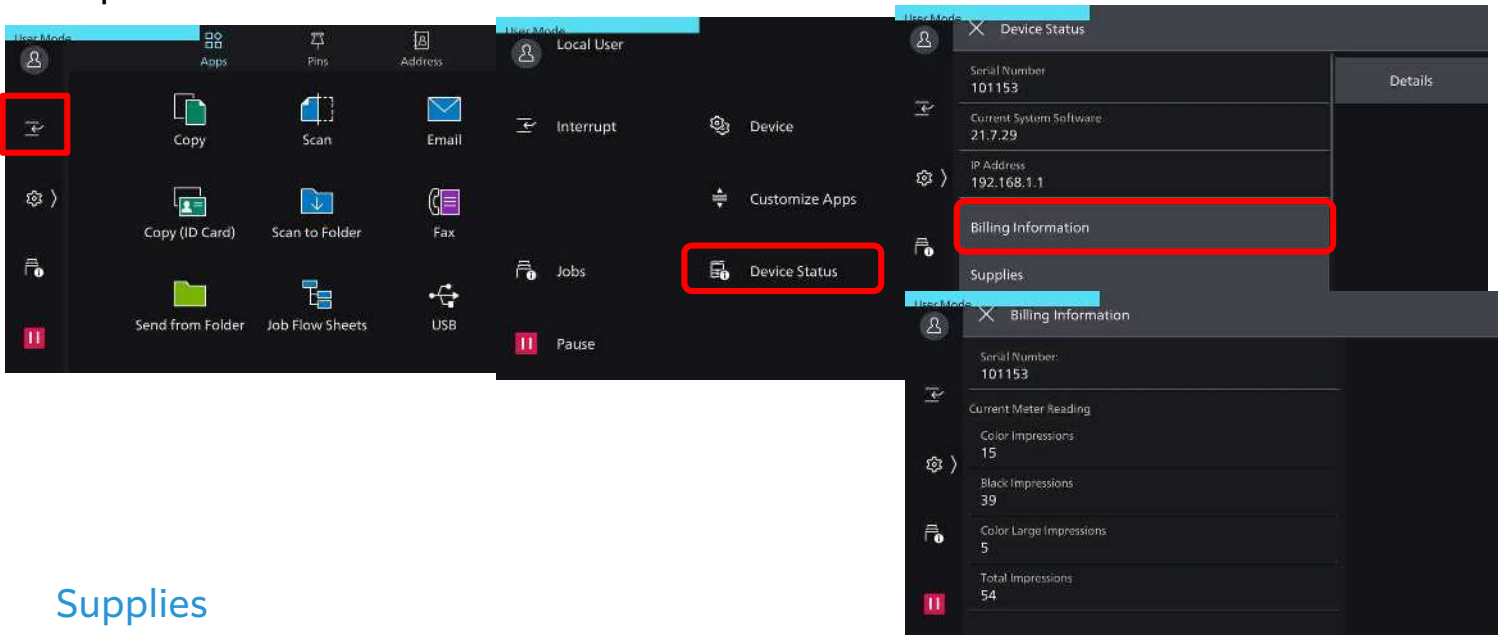

## Supplies

On the Machine Panel, tap  icon  
Select <Device Status>, <supplies>  
The status of consumables is shown as:  
"OK", "Replace Soon (Order Now)", or "Replace Now"  
For toner, the amount is shown in percentage (0 to 100%).  
Scroll down to display Other Consumables .

Replace only when the alert Message displays "Replace Now"

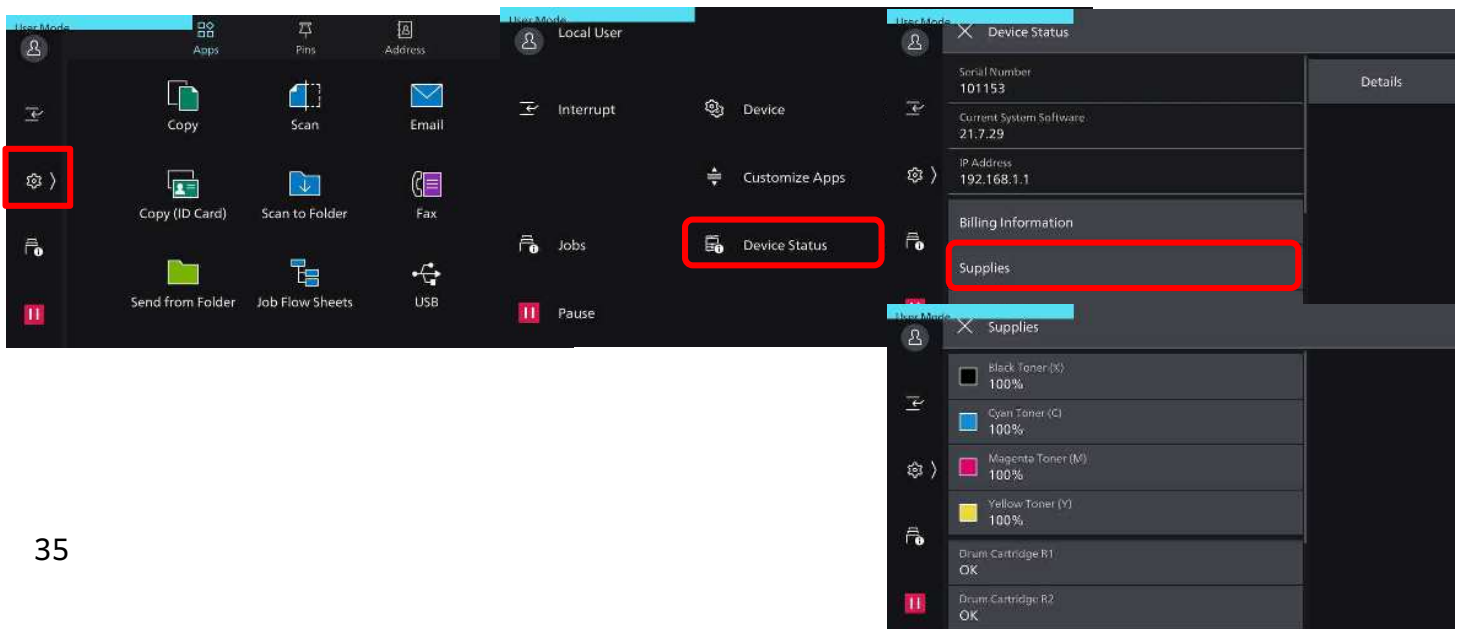

# Consumables Part No



Standard Unit



B1 Finisher with Booklet Maker



C4 Finisher with Booklet Maker



D6 Finisher with Booklet Maker & Folding

Consumables Part Number	Product Code	Quantity/Box
Toner Cartridge Black [K]	CT203450	1 unit/box
Toner Cartridge Cyan [C]	CT203451	1 unit/box
Toner Cartridge Magenta [M]	CT203452	1 unit/box
Toner Cartridge Yellow [Y]	CT203453	1 unit/box
Drum Cartridge (CMYK)	CT351242	1 unit/box
Waste Toner Container	CWAA0986	1 unit/box
(For Apeos C8180/ C7580/ C6580)		
50 Sheet Staple Cartridge types XE for Finisher-C4/D6*1	CWAA0856	5000 staples X 2boxes
65 Sheet Staple Cartridge types XH for Finisher-C4*2	CWAA0855	5000 staples X 3boxes
Staple Cartridge for D6*3	CWAA0855	5000 staples X 4boxes

\*1: Staple Cartridge types XE (2pcs) - Saddle Staple 5,000 pieces x 2boxes for Finisher C4 & D6, Finisher C4 & D6 with Booklet Maker

\*2: Staple Cartridge types XH (3pcs) - 5,000 pieces x 3boxes for Finisher C4, Finisher C4 with Booklet Maker

\*3: Staple Cartridge - 5,000 pieces x 4boxes for Finisher D6 or Finisher D6 with Booklet Maker

## Remarks: (Refer to FBMV Brochure details)

For C4 Finisher staple Cartridge (50 / 65 sheets)\*optional / Booklet staples (20 sheets)

For D6 Finisher staple Cartridge (100 sheets) / Booklet staples (30 sheets)

### Replace Toner Cartridges

The following messages are displayed on the touch screen depending on the amount of toner remaining. Replace the toner cartridge according to the message.

Message :	Remaining Yield:	Solution:
Please order a Yellow Toner [Y] Cartridge	Black: Approx 3,500pages Others: Approx 2,500 pages	Do not required to replace immediately. Order Toner Cartridge as displayed.
Yellow Toner [Y] Cartridge needs to be replaced soon.	Approx. 40 pages	Replace toner cartridge with a new one.
Yellow Toner [Y] Cartridge needs to be replaced.	-	Machine will stop, replace toner cartridge with a new one.

### Replace Waste Toner Cartridges R5

The following messages are displayed on the touch screen according to the status of the waste container.

Message :	Remaining Yield:	Solution:
Please order a Waste Toner Container	Approx. 3,600 pages	Order the waste toner container
The Waste Toner Container needs to be replaced.	-	Machine will stop, replace waste container with a new one.

# Job Status

Allows you to check current, pending, and completed jobs. You can also cancel or resume a pending /inactive job.

1. From machine home screen, tap

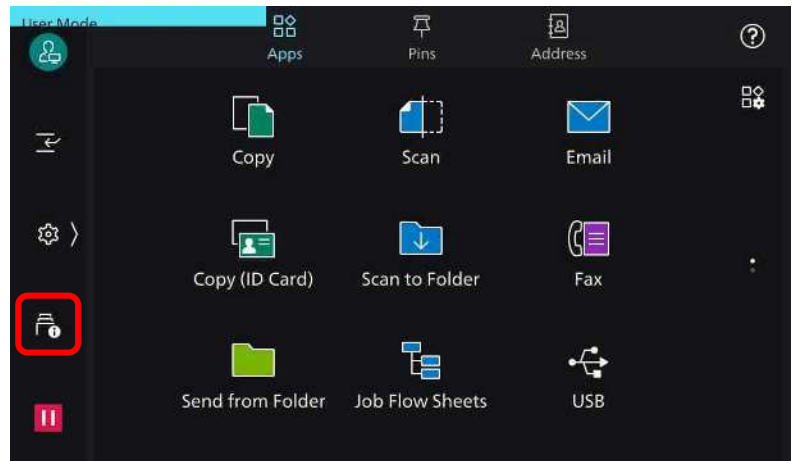

2. The **[All Jobs]** screen displays the current or pending jobs.  
Select a job, to view the status of the job

- a) Completed [successful]
- b) Completed with error [unsuccessful]

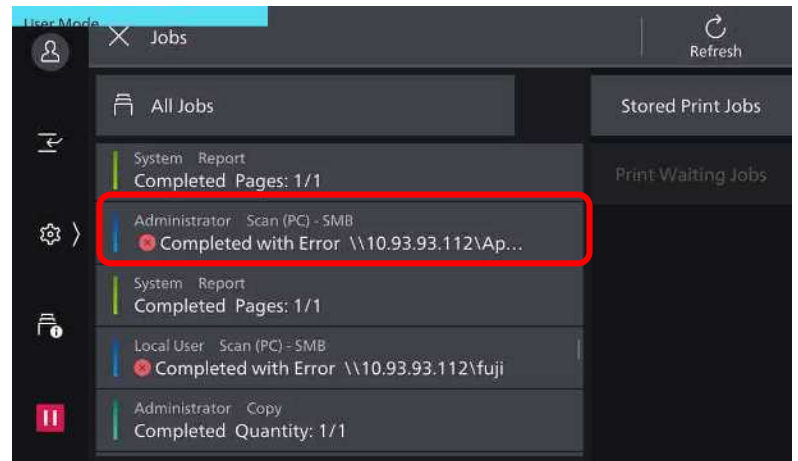

3. Click on the job log to display the details of the job

If an error occurs, the error will be indicated in the message.  
tap [job history report] to print out the report

4. Select **[X]** to close the screen.

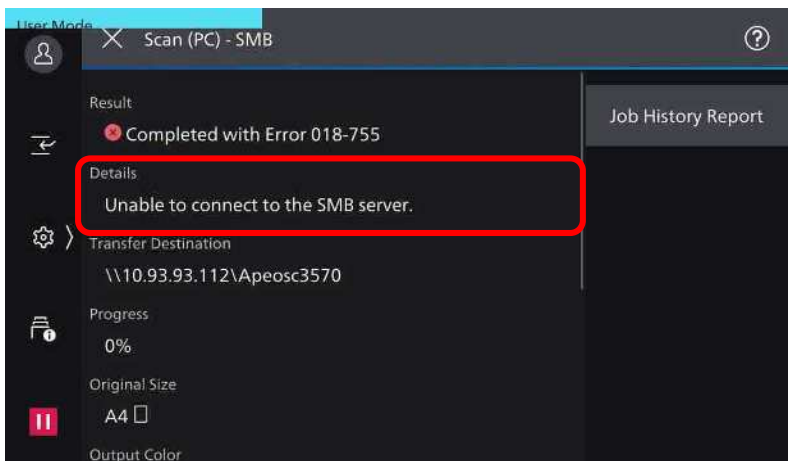

# Register New Address (Email / Fax Recipient)

You can register frequently used addresses on the address book. Select address type from Fax, IP Fax, I-fax, Email & Server. (Up to 5000 addresses can be stored.)

1. From machine home page, select **[Address Book]** icon on the top left corner and tap
2. Tap **[Add Contact]**. 

## Option 1: add fax numbers

- 1) Enter recipient name and tap **[not set]** to enter the fax number, use the keyboard to enter fax number.
- 2) Press **[done]** to close fax number window and confirm the entry, then tap **[OK]** to continue and register the number.

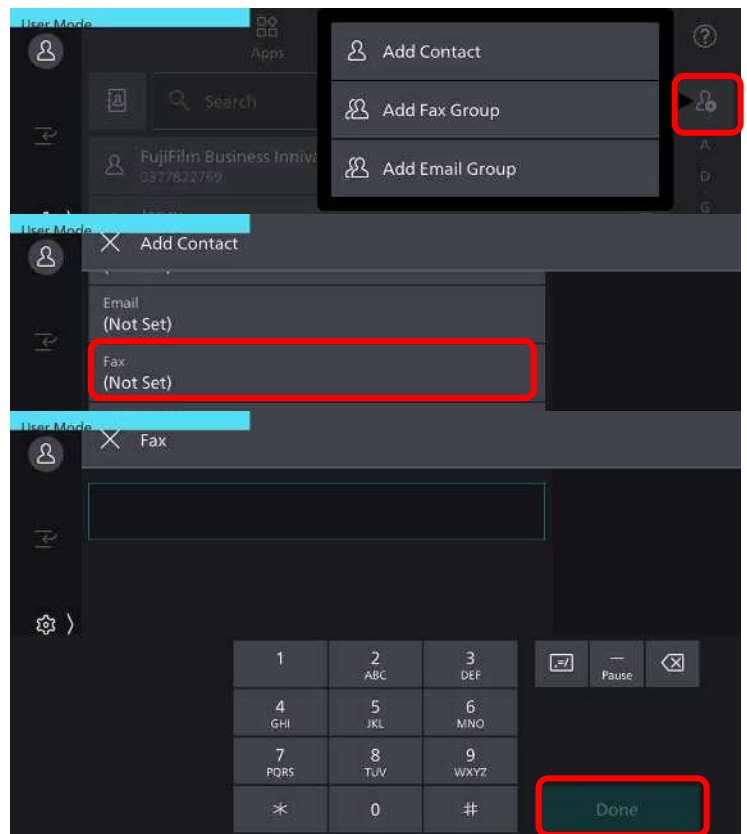
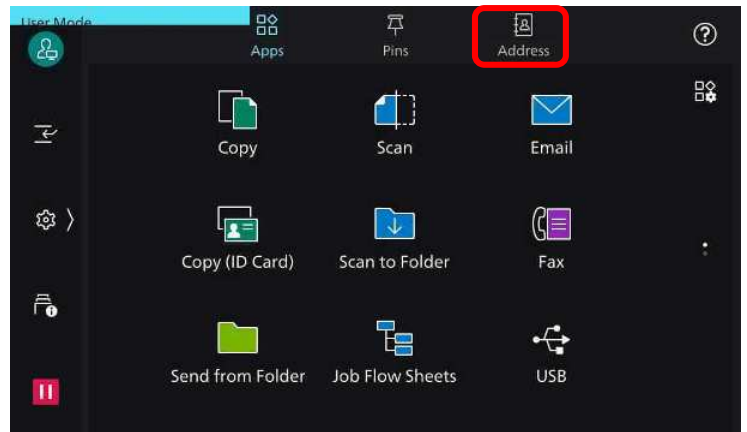

## Option 2: add email address

1. Repeat step 1 and 2 in option 1
2. Enter recipient name and tap email **[not set]**
3. Enter a name for the recipient. Tap **[OK]** to continue.
4. Confirm the entries, and tap **[OK]** to register and exit.

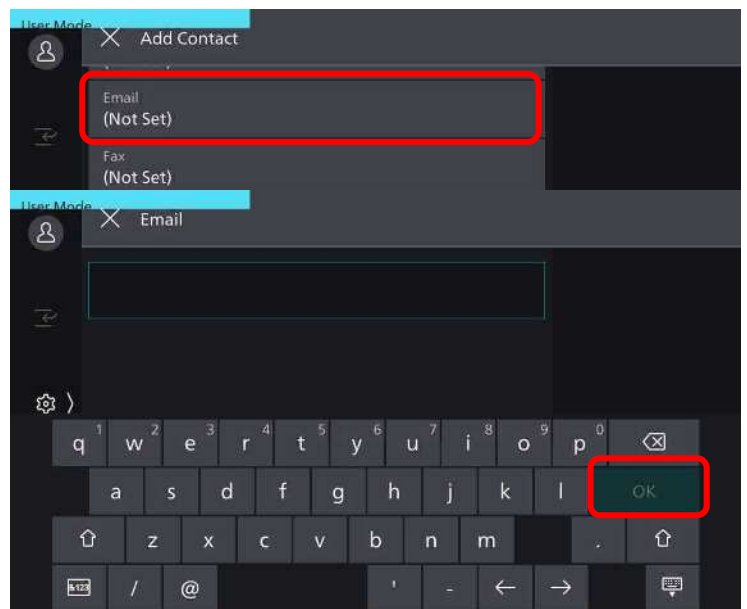

# Support & Download (Drivers & Self-help)

Check out FUJIFILM Business Innovation website @ [fujifilm.com/fbmy](http://fujifilm.com/fbmy)

## Apeos C8180 How To, FAQ & Answers

Not your product? Search again

Drivers

Self Help

Documentation

Utilities

Learning

Type your question here...e.g How to remove a Windows print driver



Print



Fax



Image Quality



Copy



Scan



Consumables

## Apeos C8180 Drivers & Downloads

Not your product? Search again

Drivers

Self Help

Documentation

Utilities

Learning

Operating System

Windows 10 64bit

Language

English

Help with Driver Selection >



### Recommended

Easy Setup Installer >

Version: 1.0.7.16 [Compatibility](#) > [File Information](#) >



**FUJIFILM**  
Value from Innovation

FUJIFILM Business Innovation

[Solutions & Services](#) [Products](#) [Support & Drivers](#) [Company Insights](#) [Contact Us](#)

Sales Enquiries  
For Equipment &  
Software

1300-88-1163

[Sales Enquiry](#)

For Online Support,  
Technical Support,

[Technical Support](#)

Training and Toner  
Ordering

[Toner Ordering](#)

For Used Consumables  
Collection

[Used Consumables  
Collection](#)

For Invoicing, Billing and  
Meter Reading

[Meter Reading  
Submission](#)

### Contact Information

Title  
Mr.

Name \*

Mobile Number \*

Email \*

Customer Reference

USA reference specified by you that you required FUJIFILM Business Innovation to use. This is not mandatory.

### Organisation Information

Product/Model \*

Serial Number \*

Account

Company Name

Machine Address \*

This is the address where the machine is located. Not an accounting or headquarters address.

Hours of Operation

### Support Request Information

### Live Chat

Hi, how can i help you?

Welcome to FUJIFILM Business Innovation Malaysia Live Chat. Our operating hours are from 8.30am to 6.00pm, Monday to Friday. We are closed on Public Holidays.

Please enter your details below:

Name  Required

Phone number  Required

Email  Optional

Serial Number  Optional

Request Type  Please Select

Cancel

Start Chat

Powered by GENESYS

# EP-BB Self Registration (subject to configuration)

For Green Report, kindly Self-Register your account 30 days after activation date. Please follow the steps below to register.

Open a web browser and key in the below address

[https://service-fb.fujifilm.com/direct\\_app/](https://service-fb.fujifilm.com/direct_app/)

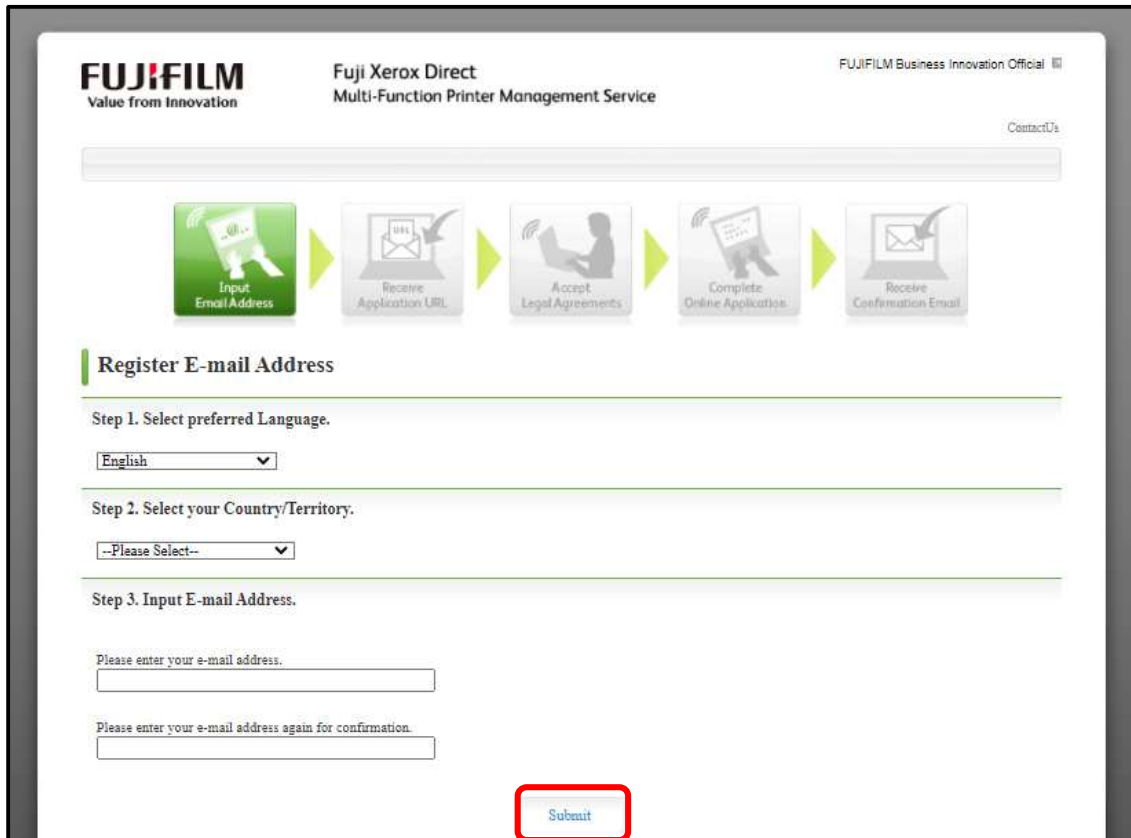

The screenshot shows the Fujifilm registration interface. At the top, it displays the Fujifilm logo, 'Fuji Xerox Direct Multi-Function Printer Management Service', and 'FUJIFILM Business Innovation Official'. A progress bar at the top indicates five steps: 'Input Email Address', 'Receive Application URL', 'Accept Legal Agreements', 'Complete Online Application', and 'Receive Confirmation Email'. The current step is 'Register E-mail Address', which includes three sub-steps: 'Step 1. Select preferred Language.' with a dropdown menu set to 'English'; 'Step 2. Select your Country/Territory.' with a dropdown menu set to '--Please Select--'; and 'Step 3. Input E-mail Address.' with two text input fields for the email address and its confirmation. A red box highlights the 'Submit' button at the bottom right.

An e-mail notification with the personalized URL will be sent via e-mail

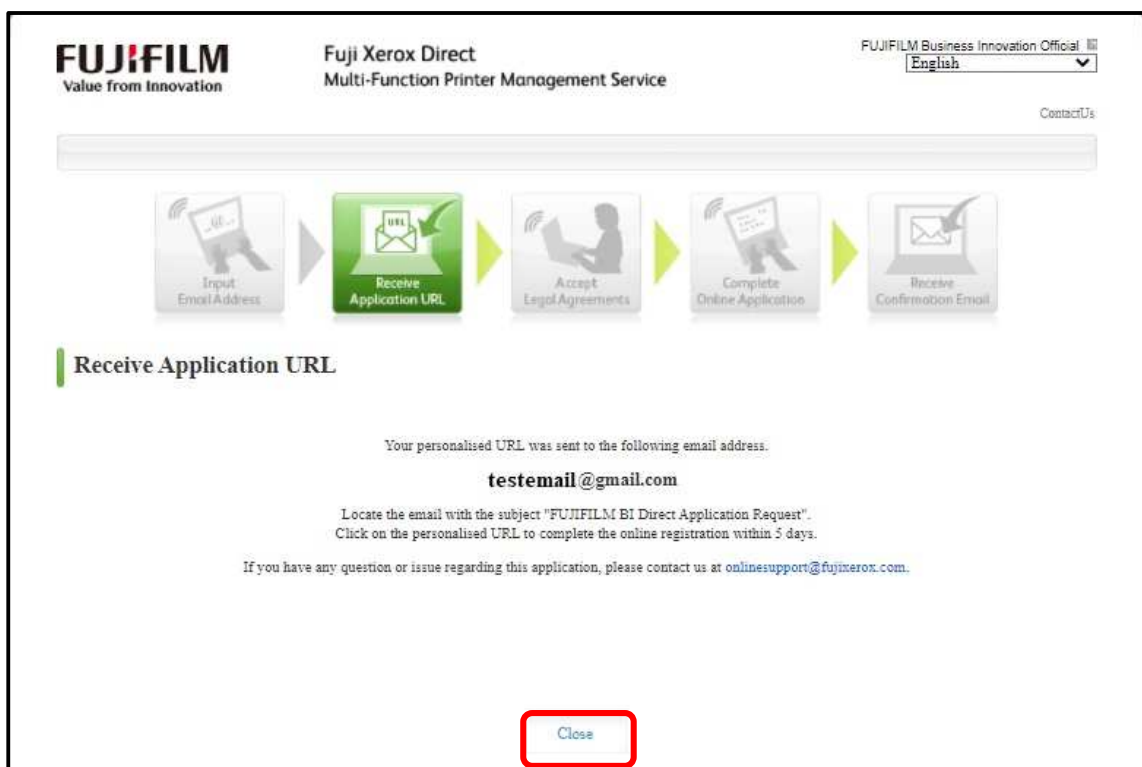

The screenshot shows the Fujifilm registration interface at the 'Receive Application URL' step. The progress bar at the top indicates five steps: 'Input Email Address', 'Receive Application URL', 'Accept Legal Agreements', 'Complete Online Application', and 'Receive Confirmation Email'. The current step is 'Receive Application URL', which displays the message: 'Your personalised URL was sent to the following email address: **testemail@gmail.com**'. Below this, it instructs the user to 'Locate the email with the subject "FUJIFILM BI Direct Application Request". Click on the personalised URL to complete the online registration within 5 days.' and provides contact information: 'If you have any question or issue regarding this application, please contact us at [online-support@fujixerox.com](mailto:online-support@fujixerox.com)'. A red box highlights the 'Close' button at the bottom center.



Click on the URL and you will be redirected to the following link. Proceed with the application by accepting the Legal Agreements.

**FUJIFILM** Value from Innovation

Fuji Xerox Direct  
Multi-Function Printer Management Service

FUJIFILM Business Innovation Official  
English

Contact Us

Accept Legal Agreements → Complete Online Application → Receive Confirmation Email

### Legal Agreements

Web Site Usage Notes and Legal Disclaimers

TERMS OF USE FOR THIS WEB SITE

By using any of the websites (each a "Site") operated by or for and on behalf of FUJIFILM Business Innovation, you agree to be bound by the following terms and conditions ("Terms and Conditions").

1. Registered User of Site

I have read and agreed with the disclaimer.  
 I have read and accepted the terms of the privacy policy. Click [here](#) to review the policy.

**Submit**

Complete the Online Application form to Continue. Your application will be processed. Thank you.

Accept Legal Agreements → **Complete Online Application** → Receive Confirmation Email

### Application Form

\*Denotes a required field

Contact Information	
Title	<input type="text"/>
First Name	<input type="text"/>
* Last Name	<input type="text"/>
* Display Name	<input type="text"/>
* Phone	<input type="text"/>
Email	testemail@email.com
* Promotional Emails	<input checked="" type="radio"/> Wish to receive <input type="radio"/> Do not receive
Organisation Information	
* Type of business	<input checked="" type="radio"/> Organisation <input type="radio"/> Individual
* Organisation	<input type="text"/>
* Address	<input type="text"/> <input type="text"/> <input type="text"/>
* Post Code	<input type="text"/>
Country/Territory	Malaysia
* Please provide details for one product.	Product/Model <input type="text"/> <a href="#">Which product do I have?</a> Serial Number <input type="text"/>

**Continue**





This Quick User Guide is printed on FUJIFILM ApeosPro C8180/7580/6580  
Copyright Reserved © 2022 by Customer Training Department  
FUJIFILM Business Innovation Asia Pacific Pte. Ltd.  
Printed in Malaysia

**For Service & Supplies Enquiries (Nationwide)**

**Toll Free : 1-300-88-1163**

**Online support: [fujifilm.com/fbmy](https://www.fujifilm.com/fbmy)**